

brother

Operation Manual

Sewing Machine

Product Code: 888-S33/S36

1 KNOWING YOUR
SEWING MACHINE

2 SEWING BASICS

3 UTILITY STITCHES

4 APPENDIX

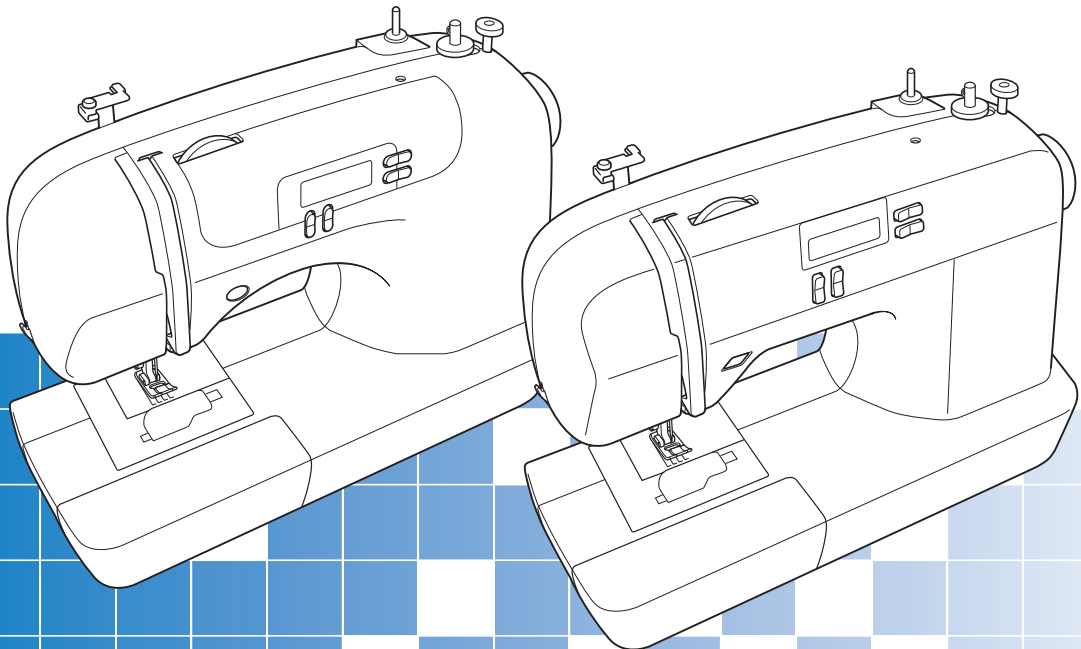

Be sure to read this document before using the machine.

We recommend that you keep this document nearby for future reference.

IMPORTANT SAFETY INSTRUCTIONS

Please read these safety instructions before attempting to use the machine.

DANGER

- To reduce the risk of electric shock:

- 1** Always unplug the machine from the electrical outlet immediately after using, when cleaning, when making any user servicing adjustments mentioned in this manual, or if you are leaving the machine unattended.

WARNING

- To reduce the risk of burns, fire, electric shock, or injury to persons.

- 2** Always unplug the machine from the electrical outlet when making any adjustments mentioned in the instruction manual:
 - To unplug the machine, switch the machine to the symbol “O” position to turn it off, then grasp the plug and pull it out of the electrical outlet. Do not pull on the cord.
 - Plug the machine directly into the electrical outlet. Do not use an extension cord.
 - Always unplug your machine if the power is cut.
- 3** Electrical Hazards:
 - This machine should be connected to an AC power source within the range indicated on the rating label. Do not connect it to a DC power source or inverter. If you are not sure what kind of power source you have, contact a qualified electrician.
 - This machine is approved for use in the country of purchase only.
- 4** Never operate this machine if it has a damaged cord or plug, if it is not working properly, if it has been dropped or damaged, or water is spilled on the unit. Return the machine to the nearest authorized dealer or service center for examination, repair, electrical or mechanical adjustment.

- While the machine is stored or in use if you notice anything unusual, such as an odor, heat, discoloration or deformation, stop using the machine and immediately unplug the power cord.
 - When transporting the machine, be sure to carry it by its handle. Lifting the machine by any other part may damage the machine or result in the machine falling, which could cause injuries.
 - When lifting the machine, be careful not to make any sudden or careless movements, otherwise you may injure your back or knees.
- 5** Always keep your work area clear:
 - Never operate the machine with any air openings blocked. Keep ventilation openings of the machine and foot control free from the build up of lint, dust, and loose cloth.
 - Do not store objects on the foot controller.
 - Do not use extension cords. Plug the machine directly into the electrical outlet.
 - Never drop or insert any object into any opening.
 - Do not operate where aerosol (spray) products are being used or where oxygen is being administered.
 - Do not use the machine near a heat source, such as a stove or iron; otherwise, the machine, power cord or garment being sewn may ignite, resulting in fire or an electric shock.
 - Do not place this machine on an unstable surface, such as an unsteady or slanted table, otherwise the machine may fall, resulting in injuries.
 - 6** Special care is required when sewing:
 - Always pay close attention to the needle. Do not use bent or damaged needles.
 - Keep fingers away from all moving parts. Special care is required around the machine needle.
 - Switch the machine to the symbol “O” position to turn it off when making any adjustments in the needle area.
 - Do not use a damaged or incorrect needle plate, as it could cause the needle to break.
 - Do not push or pull the fabric when sewing, and follow careful instruction when freehand stitching so that you do not deflect the needle and cause it to break.

7 This machine is not a toy:

- Your close attention is necessary when the machine is used by or near children.
- The plastic bag that this machine was supplied in should be kept out of the reach of children or disposed of. Never allow children to play with the bag due to the danger of suffocation.
- Do not use outdoors.

8 For a longer service life:

- When storing this machine, avoid direct sunlight and high humidity locations. Do not use or store the machine near a space heater, iron, halogen lamp, or other hot objects.
- Use only neutral soaps or detergents to clean the case. Benzene, thinner, and scouring powders can damage the case and machine, and should never be used.
- Always consult the operation manual when replacing or installing any assemblies, the presser feet, needle, or other parts to assure correct installation.

9 For repair or adjustment:

- If the Light unit (light-emitting diode) is damaged, it must be replaced by authorized dealer.
- In the event a malfunction occurs or adjustment is required, first follow the troubleshooting table in the back of the operation manual to inspect and adjust the machine yourself. If the problem persists, please consult your local authorized Brother dealer.

Use this machine only for its intended use as described in this manual.

Use accessories recommended by the manufacturer as contained in this manual.

The contents of this manual and specifications of this product are subject to change without notice.

For additional product information, visit our web site at www.brother.com

SAVE THESE INSTRUCTIONS

This machine is intended for household use.

FOR USERS IN COUNTRIES EXCEPT CENELEC COUNTRIES

This appliance is not intended for use by persons (including children) with reduced physical, sensory or mental capabilities, or lack of experience and knowledge, unless they have been given supervision or instruction concerning use of the appliance by a person responsible for their safety. Children should be supervised to ensure that they do not play with the appliance.

FOR USERS IN CENELEC COUNTRIES

This appliance can be used by children aged from 8 years and above and persons with reduced physical, sensory or mental capabilities or lack of experience and knowledge if they have been given supervision or instruction concerning use of the appliance in a safe way and understand the hazards involved. Children shall not play with the appliance. Cleaning and user maintenance shall not be made by children without supervision.

FOR USERS IN THE UK, EIRE, MALTA AND CYPRUS ONLY

IMPORTANT

- In the event of replacing the plug fuse, use a fuse approved by ASTA to BS 1362, i.e. carrying the  mark, rating as marked on plug.
- Always replace the fuse cover. Never use plugs with the fuse cover omitted.
- If the available electrical outlet is not suitable for the plug supplied with this equipment, you should contact your authorized Brother dealer to obtain the correct lead.

CONTENTS

IMPORTANT SAFETY INSTRUCTIONS	1
CONTENTS	3
1. KNOWING YOUR SEWING MACHINE	4
NAMES OF MACHINE PARTS AND THEIR FUNCTIONS	4
The main parts	4
Needle and presser foot section	4
Operation buttons	5
Operation panel	5
Flat bed attachment	5
ACCESSORIES	6
Optional accessories	6
USING YOUR SEWING MACHINE	7
Power supply precautions	7
Power supply	7
Foot controller	7
Sewing speed controller	8
(for models equipped with the start/stop button)	8
Changing the needle stop position	8
THREADING THE MACHINE	9
Winding the bobbin	9
Lower threading	11
Upper threading	13
Drawing up the lower thread	15
REPLACING THE NEEDLE	16
Needle types and their uses	16
Checking the needle	17
Replacing the needle	17
Sewing with a twin needle	19
REPLACING THE PRESSER FOOT	20
Replacing the presser foot	20
Removing the presser foot holder	21
2. SEWING BASICS	22
SEWING	22
General sewing procedure	22
ADJUSTING THE STITCH LENGTH AND WIDTH	22
Selecting stitching	22
Starting to sew	23
Thread tension	25
USEFUL SEWING TIPS	25
Trial sewing	25
Changing the sewing direction	25
Sewing curves	26
Sewing thick fabrics	26
Sewing thin fabrics	26
Sewing stretch fabrics	26
Using a free-arm style	27
3. UTILITY STITCHES	28
OVERCASTING STITCHES	28
BASIC STITCHING	28
Basic stitching	28
BLIND HEM STITCHING	29
BUTTONHOLE SEWING	30
Button sewing	33
ZIPPER INSERTION	34
SEWING STRETCH FABRICS AND ELASTIC TAPE	35
Stretch stitching	35
Elastic attaching	35
APPLIQUÉ, PATCHWORK AND QUILT STITCHING	36
Appliqués	36
Patchwork (crazy quilt) stitching	36
Piecing	37
Quilting	37
Free-motion quilting	38
REINFORCEMENT STITCHING	39
Triple stretch stitching	39
Bar tack stitching	40
DECORATIVE STITCHING	41
Fagoting	41
Scallop stitching	42
Smocking	42
Shell tuck stitching	43
Joining	43
Heirloom stitching	44
4. APPENDIX	45
STITCH SETTINGS	45
Utility stitches	45
MAINTENANCE	50
Restrictions on oiling	50
Precautions on storing the machine	50
Cleaning the machine surface	50
Cleaning the bobbin case	50
TROUBLESHOOTING	52
ERROR MESSAGES	55
Operation beep (for models equipped with the operation beep)	55
INDEX	56

1 KNOWING YOUR SEWING MACHINE

NAMES OF MACHINE PARTS AND THEIR FUNCTIONS

The main parts

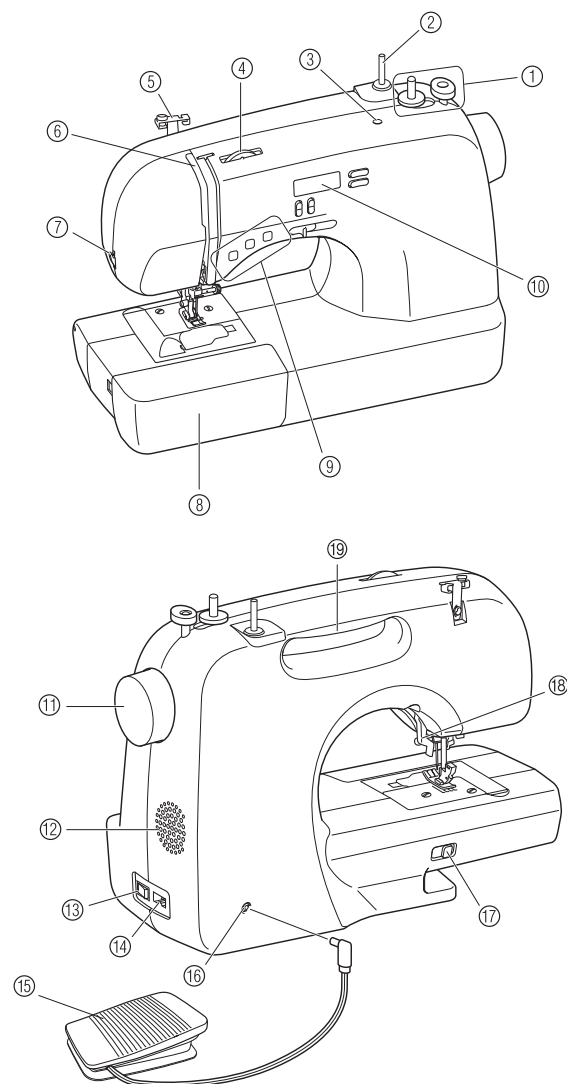

- ① **Bobbin winder** (page 9)
- ② **Spool pin** (pages 9 and 13)
- ③ **Hole for extra spool pin** (page 19)
- ④ **Upper tension-control dial** (page 25)
- ⑤ **Thread guide** (pages 9 and 13)
- ⑥ **Thread take-up lever** (page 14)
- ⑦ **Thread cutter** (page 24)
- ⑧ **Flat bed attachment with accessory compartment** (pages 5 and 27)

- ⑨ **Operation buttons** (page 5)
- ⑩ **Operation panel** (page 5)
- ⑪ **Handwheel**
Used to manually raise and lower the needle.
- ⑫ **Air vent**
This vent allows the air surrounding the motor to circulate. Do not cover the air vent while the sewing machine is being used.
- ⑬ **Main power and sewing light switch** (page 7)
- ⑭ **Jack/socket connector** (page 7)
- ⑮ **Foot controller** (page 7)
- ⑯ **Foot controller jack/socket** (page 7)
- ⑰ **Feed dog position lever** (pages 33 and 39)
- ⑱ **Presser foot lever** (page 13)
- ⑲ **Handle**
Carry the sewing machine by its handle when transporting the machine.

Needle and presser foot section

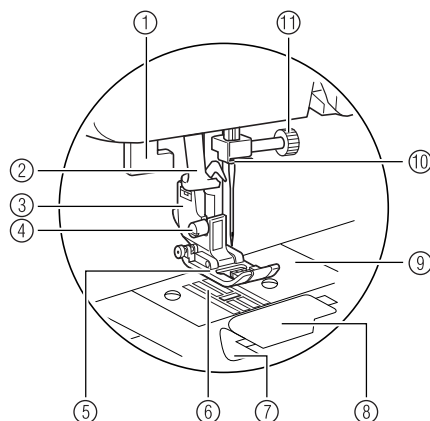



- ① **Buttonhole lever** (page 31, 40)
- ② **Needle threader** (for models equipped with the needle threader) (page 15)
- ③ **Presser foot holder**
The presser foot is installed onto the presser foot holder.
- ④ **Presser foot holder screw**
Use the presser foot holder screw to hold the presser foot holder in place.
- ⑤ **Presser foot**
The presser foot applies pressure consistently on the fabric as the sewing takes place. Attach the appropriate presser foot for the selected stitching.
- ⑥ **Feed dogs**
The feed dogs feed the fabric in the sewing direction.
- ⑦ **Quick-set bobbin** (for models equipped with the quick-set bobbin)
You can start sewing without pulling up the bobbin thread.
- ⑧ **Bobbin cover**

- ⑨ **Needle plate**
The needle plate is marked with guides for sewing straight seams.
- ⑩ **Needle bar thread guide (page 14)**
- ⑪ **Needle clamp screw**

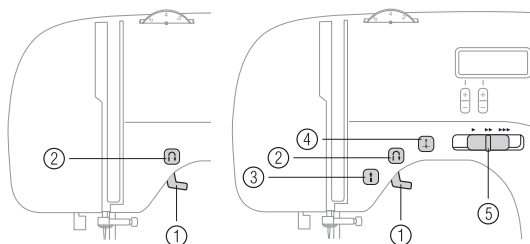

Operation buttons

The operation buttons differ depending on the sewing machine model.



- ① **Presser foot lever**
Raise and lower the presser foot.
- ② **Reverse/reinforcement stitch button** 
Press the reverse/reinforcement stitch button to sew reverse stitches. Reverse stitches are sewn by keeping the button pressed down to sew in the opposite direction. For details, refer to "Sewing reinforcement stitches" (page 24).

Buttons provided on some models

- ③ **Start/stop button** 
Press the start/stop button to start or stop sewing. The machine sews at a slow speed at the beginning of sewing while the button is depressed. When sewing is stopped, the needle is lowered in the fabric. For details, refer to "Starting to sew" (page 23).
- ④ **Needle position button** 
Press the needle position button to raise or lower the needle. Pressing the button twice sews one stitch.
- ⑤ **Sewing speed controller**
Slide this controller to adjust the sewing speed.

Operation panel

The operation panel allows you to select a stitch and specify how the stitch will be sewn.

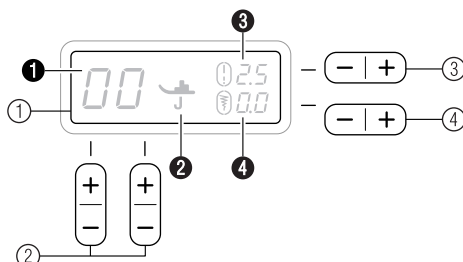

- ① **LCD (Liquid crystal display)**
The selected stitch (1), presser foot that should be used (2), stitch length in millimeters (3), and stitch width in millimeters (4) are displayed.
- ② **Stitch selection keys (page 22)**
Select the number for the stitch that you wish to use. For details, refer to "Selecting stitching" (page 22).
- ③ **Stitch length adjustment key**
Press the "-" side to reduce the stitch length; press the "+" side to increase the stitch length.
- ④ **Stitch width adjustment key**
Press the "-" side to reduce the stitch width; press the "+" side to increase the stitch width.

Flat bed attachment

The accessories are stored in a compartment inside the flat bed attachment.

- ① **Slide the flat bed attachment to the left to open it.**

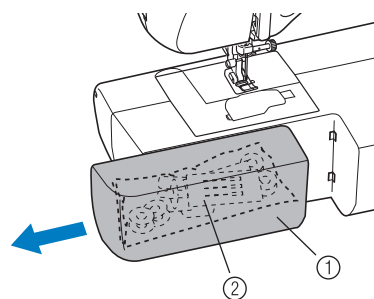

- ① Flat bed attachment
- ② Storage compartment

Note

- Put the accessories in the bag, and then store the bag inside the compartment. If the accessories are not in a bag, they may fall out, and be lost or damaged.

ACCESSORIES

The following accessories are stored in the flat bed attachment. We have designed these accessories to help you be able to carry out most sewing tasks.

Note

(For U.S.A. only)

- Foot controller: Model T
This foot controller can be used on the machine with product code 888-S33/S36. The product code is mentioned on the machine rating plate.
- The screw of the presser foot holder is available through your authorized dealer. (Part code: 132730-122)

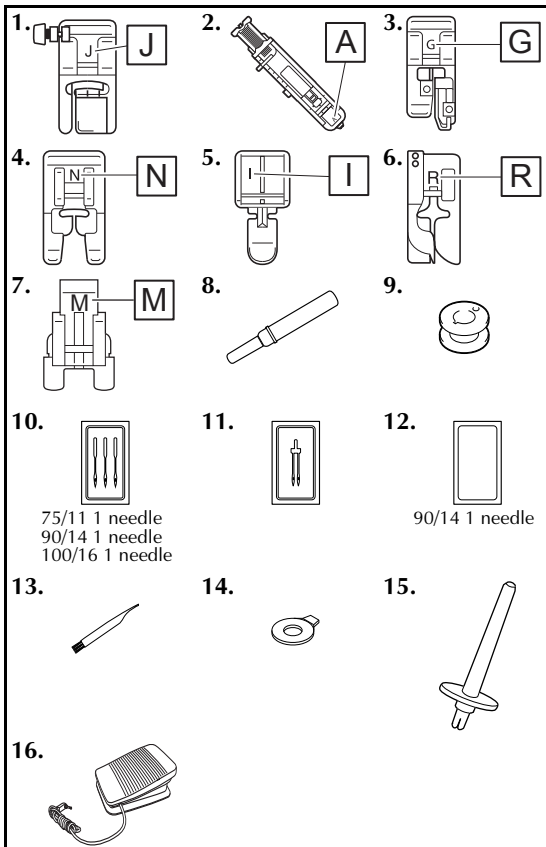

No.	Part Name	Part Code	
		Americas	Others
1	Zigzag foot "J" (on machine)	XZ5134-001	
2	Buttonhole foot "A"	XC2691-033	
3	Overcasting foot "G"	XC3098-031	
4	Monogramming foot "N"	XD0810-031	
5	Zipper foot "I"	X59370-021	
6	Blind stitch foot "R"	XE2650-001	
7	Button fitting foot "M"	XE2137-001	
8	Seam ripper	XF4967-001	
9	Bobbin (4) (One is on machine.)	SA156	SFB: XA5539-151
10	Needle set	XC8834-021	
11	Twin needle	131096-121	
12	Ball point needle (gold colored)	XD0360-021	
13	Cleaning brush	X59476-051	
14	Disc-shaped screwdriver	XC1074-051	
15	Extra spool pin	XG3488-001	
16	Foot controller	XD0501-121 (EU area) XC8816-071 (Other areas)	

Optional accessories

The following are available as optional accessories to be purchased separately.

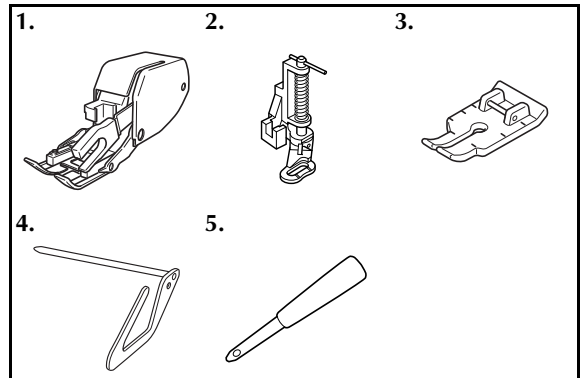

No.	Part Name	Part Code	
		Americas	Others
1	Walking Foot	SA140	F033N: XG6623-001
2	Quilting Foot	SA129	F005N: XC1948-052
3	1/4-Inch Quilting Foot	SA125	F001N: XC1944-052
4	Quilting guide	SA132	F016N: XC2215-052
5	Eyelet punch	XZ5051-001	

USING YOUR SEWING MACHINE

Power supply precautions

Be sure to observe the following precautions concerning the power supply.

⚠ WARNING

- Use only regular household electricity for the power source. Using other power sources may result in fire, electric shock, or damage to the machine.
- Make sure that the plugs on the power cord are firmly inserted into the electrical outlet and the power supply jack on the machine. Otherwise, a fire or electric shock may result.
- Do not insert the plug on the power cord into an electrical outlet that is in poor condition.
- Turn off the main power and remove the plug in the following circumstances:
 - When you are away from the machine
 - After using the machine
 - When the power fails during use
 - When the machine does not operate correctly due to a bad connection or a disconnection
 - During electrical storms

⚠ CAUTION

- Use only the power cord included with this machine.
- Do not use extension cords or multi-plug adapters with many other appliances plugged in to them. Fire or electric shock may result.
- Do not touch the plug with wet hands. Electric shock may result.
- When unplugging the machine, always turn off the main power first. Always grasp the plug to remove it from the outlet. Pulling on the cord may damage the cord, or lead to fire or electric shock.
- Do not allow the power cord to be cut, damaged, modified, forcefully bent, pulled, twisted, or bundled. Do not place heavy objects on the cord. Do not subject the cord to heat. These things may damage the cord and cause fire or electric shock. If the cord or plug is damaged, take the machine to your authorized dealer for repairs before continuing use.
- Unplug the power cord if the machine is not to be used for a long period of time. Otherwise a fire may result.

Power supply

- 1 Insert the plug into a wall outlet.

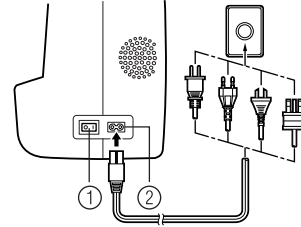

- ① Main power switch
- ② Jack/socket connector

- 2 Set the main power switch to "I".

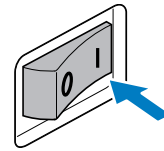

- ▶ The sewing lamp comes on when the machine is turned on.

- 3 To turn off the machine, set the main power switch to "O".

- ▶ The sewing lamp goes off when the machine is turned off.

⚡ Note

- If a power outage occurs while the sewing machine is being operated, turn off the sewing machine and unplug the power supply cord. When restarting the sewing machine, follow the necessary procedure to correctly operate the machine.
(For U.S.A. only)
- This appliance has a polarized plug (one blade wider than the other). To reduce the risk of electric shock, this plug is intended to fit in a polarized outlet only one way. If the plug does not fit fully in the outlet, reverse the plug. If it still does not fit, contact a qualified electrician to install the proper outlet. Do not modify the plug in any way.

Foot controller

Insert the foot controller plug into its jack/socket.

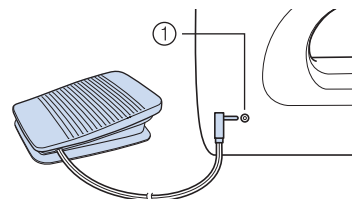

- ① Foot controller jack/socket

⚠ CAUTION

- When connecting the foot controller, be sure to turn off the sewing machine in order to prevent the machine from accidentally being started.

Depress the foot controller to start sewing, and adjust the sewing speed by changing the pressing force.

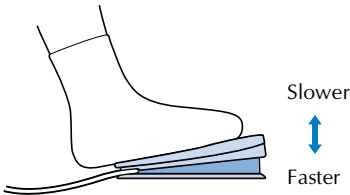

You should make sure that nothing is placed on the foot controller when the machine is not in use.

⚠ CAUTION

- Do not allow pieces of cloth and dust to build up on the foot controller. Doing so could cause a fire or an electric shock.

☀ Note

- When the foot controller is plugged in, the start/stop button cannot be used to start or stop sewing (only for models equipped with the start/stop button).

Sewing speed controller (for models equipped with the start/stop button)

- 1 Slide the sewing speed controller to select the desired sewing speed.

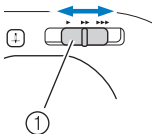

① Sewing speed controller

- The speed set using the sewing speed controller is the foot controller's maximum sewing speed.

Changing the needle stop position

Normally, the sewing machine is set to leave the needle in the fabric when sewing is stopped. Instead, the machine can be set to leave the needle raised when sewing is stopped.

- 1 Turn off the sewing machine.
- 2 Hold down the “-” side of  (①) on the left and turn on the sewing machine.

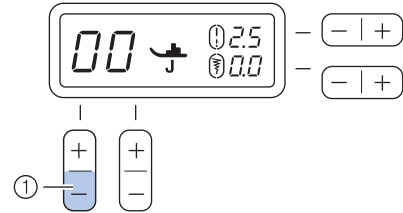

- 3 After turning on the sewing machine, release the “-” side of  (①).

- ▶ The needle stop position changes to the raised position.

📌 Memo

- Perform the same operation to change the needle stop position to the lowered position.

THREADING THE MACHINE

Winding the bobbin

This section describes how to wind the thread onto the bobbin.

- For details on the fast bobbin winding, see page 10.

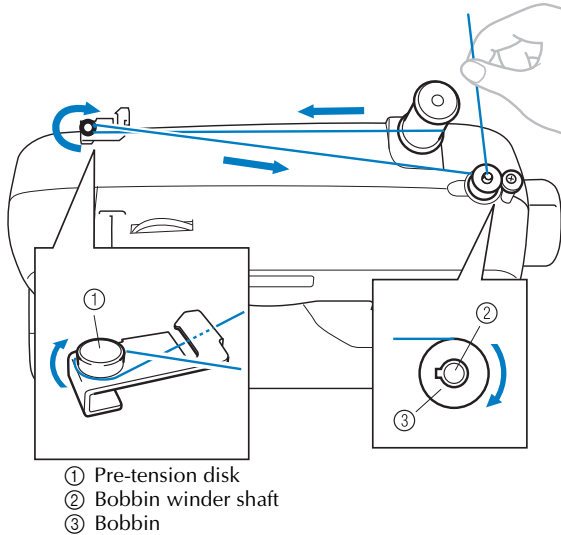

! CAUTION

- Only use bobbins (part code: SA156, SFB: XA5539-151) that have been designed for this sewing machine. Using other bobbins may cause damage to the machine.
- We designed the bobbin that comes with this machine. If you use bobbins from other models, the machine will not work properly. Only use the bobbin that comes with this machine or bobbins of the same type (part code: SA156, SFB: XA5539-151).

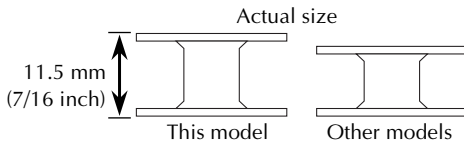

- 1 Pull up the spool pin as far as possible, and then put a spool of thread on this pin.

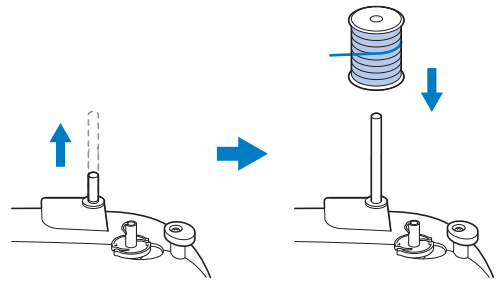

- 2 Pass the thread around the pre-tension disk.

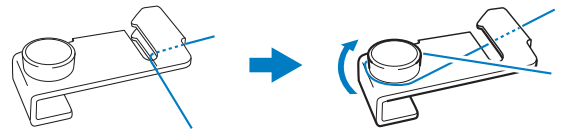

! CAUTION

- If the spool of thread is not in the right place, the thread may tangle on the spool pin.

- 3 Pass the end of the thread through the hole on the bobbin from the inside of the bobbin.

- 4 Put the bobbin onto the bobbin winder shaft and slide the bobbin winder shaft to the right. Turn the bobbin clockwise, by hand, until the spring on the shaft slides into the groove of the bobbin.

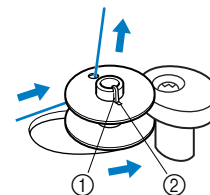

- ① Spring on the shaft
- ② Groove of the bobbin

- 5 Turn on the sewing machine.

- 6** While holding the end of the thread, gently press the foot controller or press  (start/stop button) (for models equipped with the start/stop button) to wind the thread around the bobbin a few times. Then stop the machine and trim the excess thread.

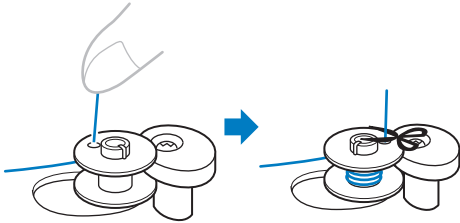

Note

- If the sewing machine is to be operated using the foot controller, connect the foot controller before turning on the machine.
- When the foot controller is plugged in, the start/stop button cannot be used to start or stop sewing (only for models equipped with the start/stop button).

⚠ CAUTION

- Make sure you follow the instructions carefully. If you do not cut the thread completely, and the bobbin is wound, when the thread runs low it may tangle around the bobbin and cause the needle to break.

- 7** Slide the sewing speed controller to the right (to set the speed to fast). (For models equipped with the sewing speed controller.)

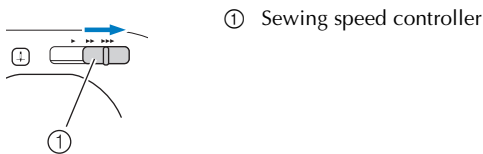

- 8** Press the foot controller or press  (start/stop button) (for models equipped with the start/stop button) to start.

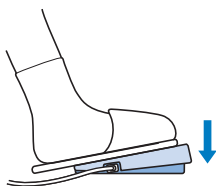

- 9** When the bobbin seems full and begins spinning slowly, take your foot off the foot controller or press  (start/stop button) (for models equipped with the start/stop button).

- 10** Cut the thread, slide the bobbin winder shaft to the left and remove the bobbin.

- 11** Slide the sewing speed controller back to its original position (for models equipped with the sewing speed controller).

Memo

- When the sewing machine is started or the handwheel is turned after winding the thread around the bobbin, the machine will make a clicking sound; this is not a malfunction.
- The needle bar does not move when you slide the bobbin winding shaft to the right.

⚠ CAUTION

- Not winding the bobbin properly may cause the thread tension to loosen, and may break the needle.

① Wound evenly
② Wound poorly

■ For models equipped with the fast bobbin winding system

- 1** Follow steps **1** through **2** of the procedure in “Winding the bobbin” to pass the thread around the pre-tension disk (page 9).

- 2** Place the bobbin on the bobbin winder shaft so that the spring on the shaft fits into the notch in the bobbin. Then slide the bobbin winder shaft to the right.

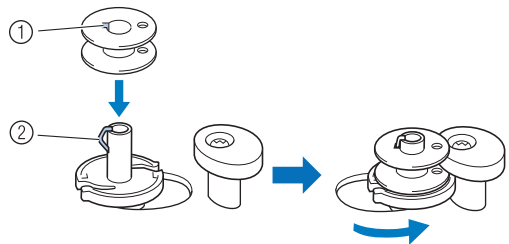

- ① Notch
② Spring

- 3** Wind the free end of the thread clockwise around the bobbin five or six times.

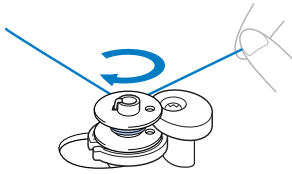

- 4** Pull the thread to the right and pass it through the slit in the bobbin winder seat.

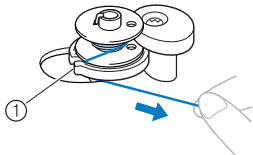

- ① Slit (with built-in cutter)
▶ The thread is cut to a suitable length.

⚠ CAUTION

- Be sure to cut the thread as described. If the bobbin is wound without cutting the thread using the cutter built into the slit in the bobbin winder seat, the thread may become tangled in the bobbin or the needle may bend or break when the bobbin thread starts to run out.

- 5** Slide the sewing speed controller to the right (to set the speed to fast) (for models equipped with the sewing speed controller).

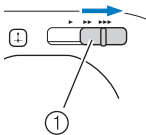

- ① Sewing speed controller

- 6** Turn on the sewing machine.

- 7** Press the foot controller or press (start/stop button) (for models equipped with the start/stop button) to start.

Note

- If the sewing machine is to be operated using the foot controller, connect the foot controller before turning on the machine.
- When the foot controller is plugged in, the start/stop button cannot be used to start or stop sewing (only for models equipped with the start/stop button).

- 8** When the bobbin begins spinning slowly, take your foot off the foot controller or press (start/stop button) (for models equipped with the start/stop button).

- 9** Cut the thread, slide the bobbin winder shaft to the left and remove the bobbin.

- 10** Slide the sewing speed controller back to its original position (for models equipped with the sewing speed controller).

Memo

- When the sewing machine is started or the handwheel is turned after winding the thread around the bobbin, the machine will make a clicking sound; this is not a malfunction.
- The needle bar does not move when you slide the bobbin winding shaft to the right.

Lower threading

Install the bobbin wound with thread.

- For more details on quick-set bobbin, see page 12.

⚠ CAUTION

- Winding the bobbin improperly may cause the thread tension to loosen, breaking the needle and resulting in injury.

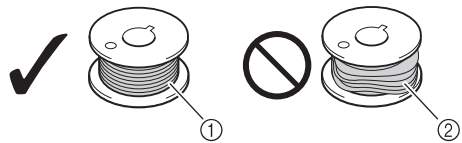

- ① Wound evenly
② Wound poorly

- Make sure you turn the power off while threading the machine. If you accidentally step on the foot controller and the machine starts to sew, you could be injured.

- 1** Raise the needle to its highest position by turning the handwheel toward you (counterclockwise) or press (needle position button) (for models equipped with the needle position button), and raise the presser foot lever.

- 2** Slide the button and open the cover.

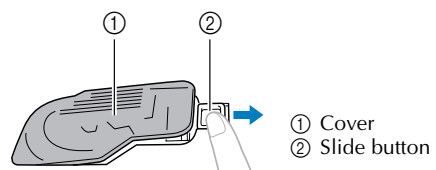

- ① Cover
② Slide button

- 3** Put the bobbin in so the thread comes out in the direction shown by the arrow.

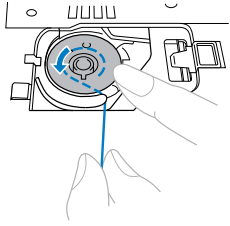

⚠ CAUTION

- Make sure you set the bobbin so the thread unrolls in the right direction. If the thread unrolls in the wrong direction, it may cause the thread tension to be incorrect or break the needle.

- 4** Hold the end of the thread, push the bobbin down with your finger, and then pass the thread through the slit, as shown.

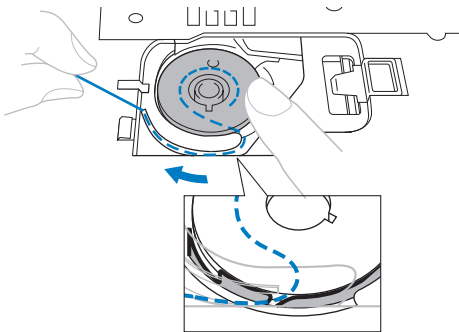

- 5** Replace the bobbin cover.

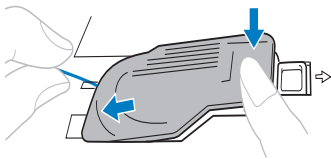

- Replace the cover so that the end of the thread comes out from the left side of the cover (as shown by the line in the diagram).

■ For models equipped with the quick-set bobbin

- 1** Raise the needle to its highest position by turning the handwheel toward you (counterclockwise) or press **+** (needle position button) (for models equipped with the needle position button), and raise the presser foot lever.

- 2** Slide the button and open the cover.

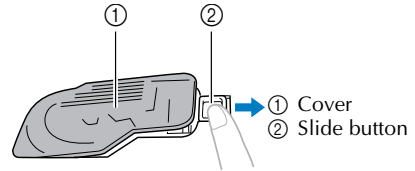

- 3** Put the bobbin in, feed the end of the thread, through the slit, and then pull the thread to cut it.

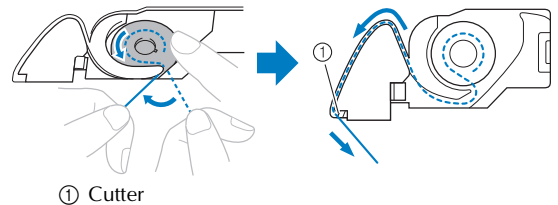

⚠ CAUTION

- Make sure you set the bobbin so the thread unrolls in the right direction. If the thread unrolls in the wrong direction, it may cause the thread tension to be incorrect or break the needle.

- Make sure that the thread is correctly inserted through the tension-adjusting spring of the bobbin case. If it is not inserted, re-insert the thread.

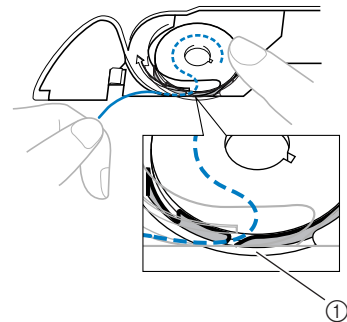

① Tension-adjusting spring

Memo

- The direction for feeding the bobbin thread is indicated by marks on the needle plate cover. Be sure to thread the machine as indicated.

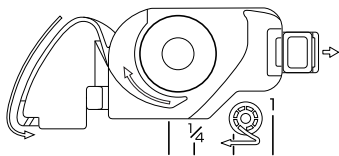

4 Replace the bobbin cover.

Memo

- You can begin sewing immediately without drawing up the bobbin thread. If you want to draw up the bobbin thread before you start to sew, follow to the procedure in “Drawing up the lower thread” (page 15).

Upper threading

Set the upper thread and thread the needle.

- For details on the needle threader, see page 14.

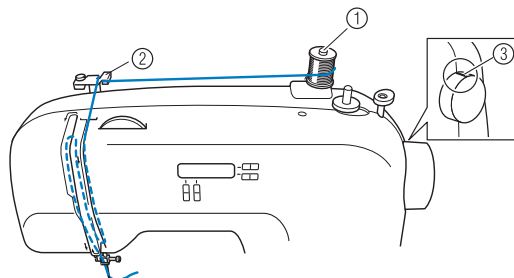

- ① Spool pin
- ② Thread guide
- ③ Mark on the handwheel

CAUTION

- **Make sure you thread the machine properly. Otherwise, the thread could tangle and break the needle.**

1 Raise the presser foot using the presser foot lever.

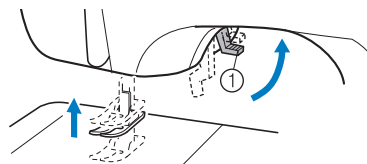

- ① Presser foot lever

2 Raise the needle by turning the handwheel toward you (counterclockwise) so that the mark on the wheel points up, or press (needle position button) (for models equipped with the needle position button) once or twice to raise the needle.

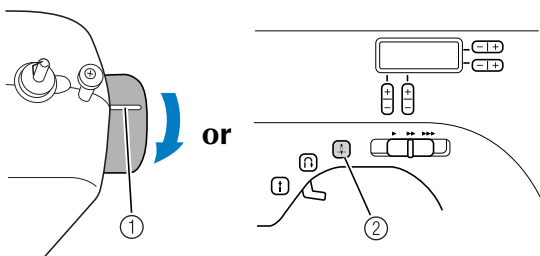

- ① Mark

- ② Needle position button

- If the needle is not correctly raised, the sewing machine can not be threaded. Be sure to turn the handwheel so that the mark on the wheel points up before threading the sewing machine.

- 3** Pull up the spool pin as far as possible, and then put a spool of thread on this pin.

⚠ CAUTION

- If the spool of thread is in the wrong place, or is set incorrectly, the thread may tangle on the spool pin and cause the needle to break.

- 4** Feed the upper thread as illustrated below.

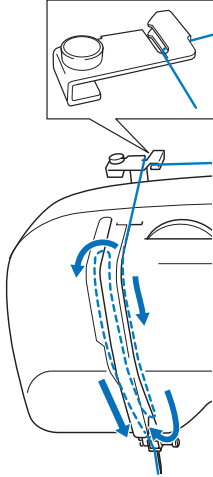

- 5** Make sure you guide the thread through the thread take-up lever from right to left.

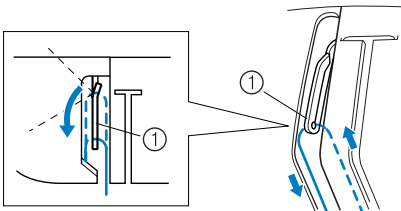

① Thread take-up lever

- 6** Put the thread behind the needle bar thread guide.

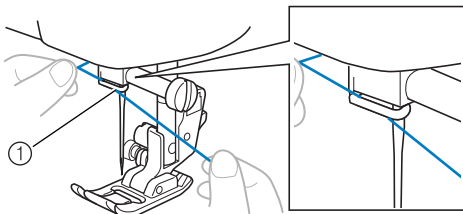

① Needle bar thread guide

- 7** Thread the needle from front to back and pull out about 5 cm (2 inch) of thread.

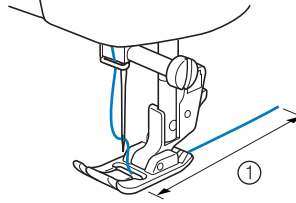

① 5 cm (2 inch)

⚡ Note

- If the thread take-up lever is lowered, the upper thread cannot be wrapped around the thread take-up lever. Make sure you raise the presser foot lever and the thread take-up lever before you feed the upper thread.
- If you incorrectly feed the thread you may cause sewing problems.

- Using the needle threader (for models equipped with the needle threader)

⚠ CAUTION

- The needle threader can only be used with home sewing machine needles size 75/11-100/16. Check the table on page 16 for the appropriate needle and thread combinations. If you are using transparent nylon mono-filament thread, you can only use needles in the range of 90/14-100/16.
- You cannot use the needle threader if you are using decorative threads or special needles, such as the twin needle and wing needle. If you are using those types of threads or needles, thread the eye of the needle by hand. Make sure the main power switch is off when threading the needle by hand.

- 1** Follow steps ① through ⑥ of the procedure in "Upper threading".

- 2** Lower the presser foot lever.

3 While lowering the needle threader lever, hook the thread onto the guide.

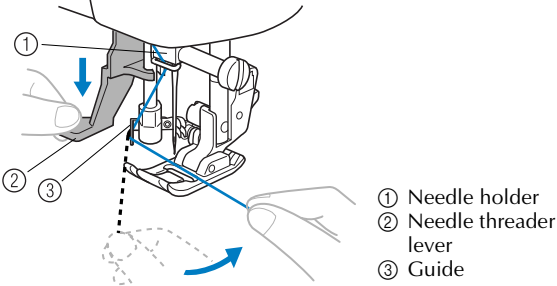

4 Fully lower the needle threader lever.

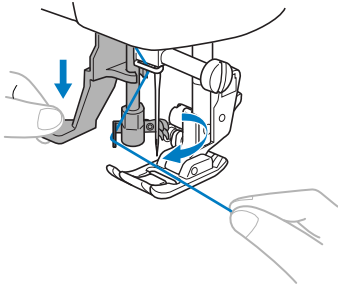

► The hook passes through the eye of the needle, and catch the thread.

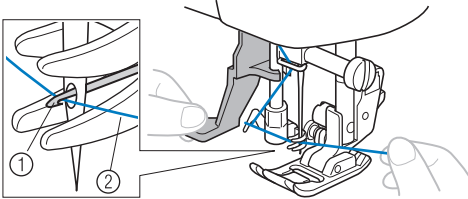

5 Release the needle threader lever. Then pull the loop of the thread.

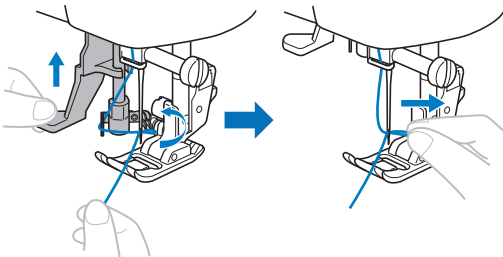

6 Pass the end of the thread as illustrated below.

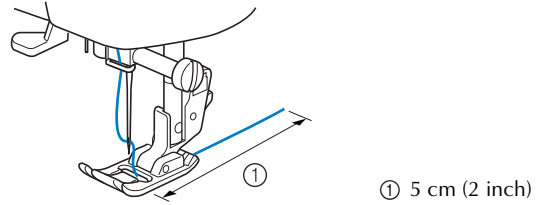

Note

- If you incorrectly feed the thread you may cause sewing problems.

Drawing up the lower thread

1 Lightly hold the end of the upper thread.

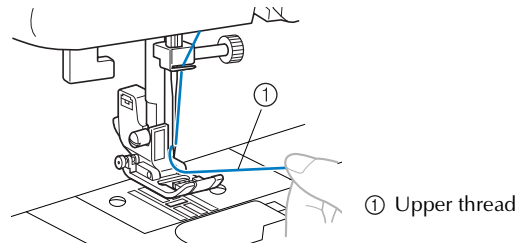

2 While holding the end of the upper thread, raise the needle either by turning the handwheel toward you (counterclockwise) so that the mark on the wheel points up or by pressing (needle position button) (for models equipped with the needle position button) once or twice.

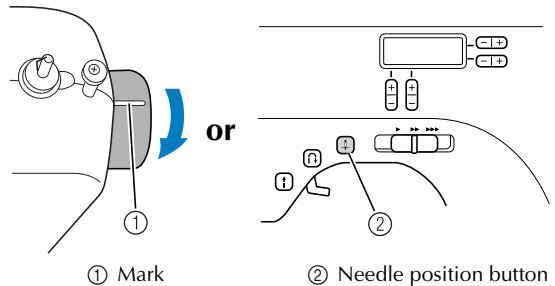

3 Pull on the upper thread to draw up the lower thread.

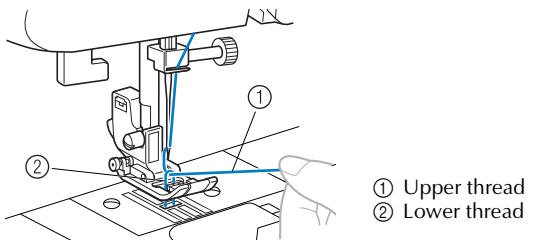

- 4** Pull out about 10 cm (4 inch) of both threads and pull them toward the back of the machine under the presser foot.

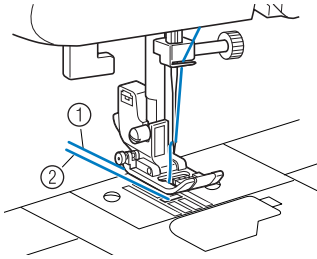

- ① Upper thread
② Lower thread

■ For models equipped with the quick-set bobbin

You can begin sewing immediately without drawing up the bobbin thread. When sewing gathers or darts, you can draw up the lower thread by hand so that some thread will be left over. Before you draw up the lower thread, put the bobbin back in.

- 1** Pass the thread along the slit in the direction of the arrow, and leave it there without cutting it.

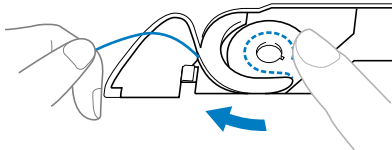

- The bobbin cover should still be removed.

- 2** Draw up the lower thread as described in steps 1 to 4.

- 3** Replace the bobbin cover.

REPLACING THE NEEDLE

This section provides information on sewing machine needles.

Needle types and their uses

Be sure to observe the following precautions concerning the handling of the needle. Failure to observe these precautions is extremely dangerous.

! CAUTION

- Only use home sewing machine needles. Use of any other needle may bend the needle or damage the machine.
- Never use bent needles. Bent needles can easily break, possibly resulting in injury.

The sewing machine needle that should be used depends on the fabric and thread thickness.

Fabric Type/ Application	Thread		Size of Needle	
	Type	Size		
Medium weight fabrics	Broad-cloth	Cotton thread	60–80	75/11–90/14
	Taffeta	Synthetic thread		
	Flannel, Gabardine	Silk thread	50–80	
Thin fabrics	Lawn	Cotton thread	60–80	65/9–75/11
	Georgette	Synthetic thread		
	Challis, Satin	Silk thread	50–80	
Thick fabrics	Denim	Cotton thread	30–50	90/14–100/16
	Corduroy	Synthetic thread	50	
	Tweed	Silk thread		
Stretch fabrics	Jersey	Thread for knits	50–60	Ball point needle (golden colored) 75/11–90/14
	Tricot			
Easily frayed fabrics		Cotton thread	50–80	65/9–90/14
		Synthetic thread		
		Silk thread		
For top-stitching		Synthetic thread	30	90/14–100/16
		Silk thread		

Memo

- The smaller the thread number, the thicker the thread; and the larger the needle number, the thicker the needle.
- Use the ball point needle when sewing on stretch fabrics or fabrics where skipped stitches easily occur.
- Use a 90/14 to 100/16 needle with transparent nylon threads, regardless of the fabric being sewn.

Ball point needle

Use the ball point needle when sewing on stretch fabrics or fabrics where skipped stitches easily occur.

Use the ball point needle for best results when sewing patterns using monogramming foot "N".

Transparent nylon thread

Use a 90/14 to 100/16 needle, regardless of the fabric or thread.

CAUTION

- The appropriate fabric, thread and needle combinations are shown in the preceding table. If the combination of the fabric, thread and needle is not correct, particularly when sewing thick fabrics (such as denim) with thin needles (such as 65/9 to 75/11), the needle may bend or break. In addition, the stitching may be uneven or puckered or there may be skipped stitches.

Checking the needle

Sewing with a bent needle is extremely dangerous since the needle may break while the machine is being operated.

Before using the needle, place the flat side of the needle on a flat surface and check that the distance between the needle and the flat surface is even.

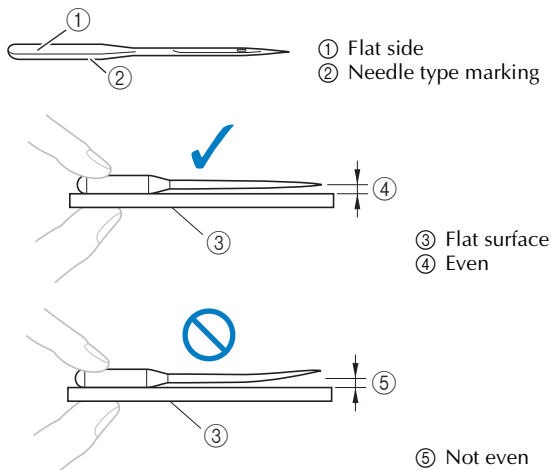

Replacing the needle

- 1 Raise the needle by turning the handwheel toward you (counterclockwise) so that the mark on the wheel points up. (With models equipped with \oplus (needle position button), raise the needle by pressing \oplus once or twice.)

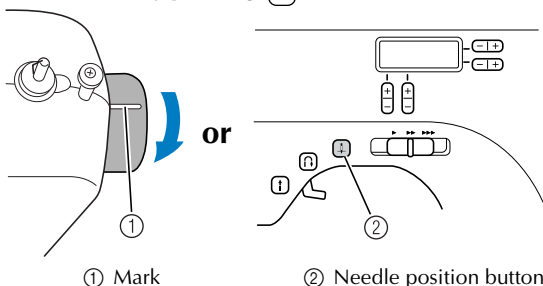

- 2 Turn off the sewing machine.

CAUTION

- Before replacing the needle, be sure to turn off the sewing machine, otherwise injuries may occur if the foot controller or the start/stop button is accidentally pressed and the machine starts sewing.

- 3 Lower the presser foot lever.

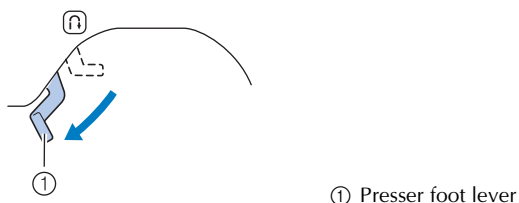

4 Remove the needle by turning the needle clamp screw counterclockwise.

Note

- If the needle clamp screw is loosened too much, the needle clamp (which holds the needle) may fall off. Therefore, do not loosen the needle clamp screw too much.

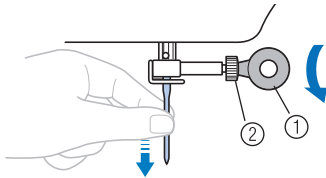

- ① Disc-shaped screwdriver
- ② Needle clamp screw

- Do not apply strong force when loosening or tightening the needle clamp screw, otherwise certain parts of the sewing machine may be damaged.

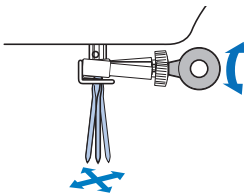

5 With the flat side of the needle toward the rear of the machine, insert the needle until it touches the needle stopper.

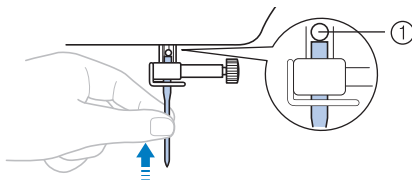

- ① Needle stopper

6 Tighten the needle clamp screw by turning it clockwise.

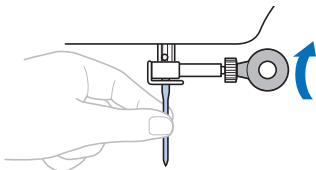

Install the twin needle in the same way.

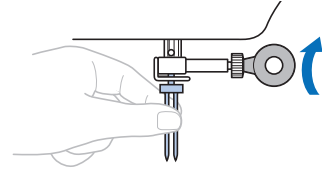

CAUTION

- Be sure to insert the needle until it touches the needle stopper and securely tighten the needle clamp screw with the disc-shaped screwdriver, otherwise the needle may break or damage may result.

Installing the needle clamp

If the needle clamp is removed, follow the procedure below to attach it to the needle bar.

- 1** As seen from the front of the machine, slide the needle clamp onto the needle bar so that the needle clamp screw is on the right side and the needle bar thread guide is at the bottom.

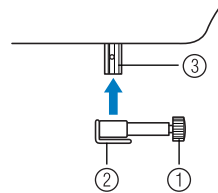

- ① Needle clamp screw
- ② Needle bar thread guide
- ③ Needle bar

- 2** Align the bottom edge of the needle holder with the end of the needle bar, and then tighten the needle clamp screw.

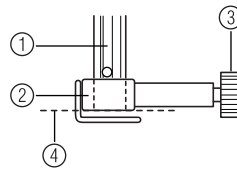

- ① Needle bar
- ② Needle holder
- ③ Needle clamp screw
- ④ Align

Sewing with a twin needle

You can sew with this needle and two top threads. You can use the same color or two different colors of thread for making decorative stitches.

For details on the stitches that can be sewn with the twin needle, refer to “Stitch settings” (page 45).

CAUTION

- Use only twin needles that have been made for this machine (part code: 131096-121). Other needles could break, and damage the machine.
- Do not sew with bent needles. The needle could break and injure you.
- You can not use the needle threader to thread the twin needle. Instead, thread the twin needle by hand, from front to back. Using the needle threader may damage the machine.
- When using the twin needle, be sure to select an appropriate stitch, otherwise the needle may break or the machine may be damaged.
- Select a stitch width of 5.0 mm (3/16 inch) or less, otherwise the needle may break or the machine may be damaged.
- After adjusting the stitch width, slowly turn the handwheel toward you (counterclockwise) and check that the needle does not touch the presser foot. If the needle hits the presser foot, the needle may bend or break.
- When using the twin needle, be sure to attach zigzag foot “J”, otherwise the needle may break or the machine may be damaged.
- When changing the sewing direction, be sure to raise the needle before turning the fabric. If the fabric is turned while the needle is lowered, the needle may bend or break.

- 1 Attach the twin needle.**
Attach the twin needle in the same way as a single needle (page 17).
- 2 Attach the extra spool pin.**
Put the extra spool pin in the hole on the top of the machine. Put the second spool of thread onto the extra spool pin.

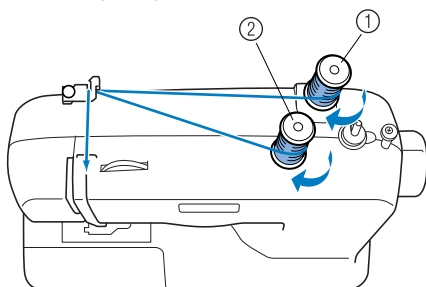

- ① First spool
- ② Second spool

- 3 Use the thread from the first spool to thread the machine to the needle bar thread guide.**
The path for threading the machine to the needle bar thread guide is the same as for normally threading the machine (for a single needle). See page 14 for more details.

- 4 Thread the left needle from front to back.**

- 5 Use the thread from the second spool to thread the machine to the thread take-up lever.**
The path for threading the machine to the thread take-up lever is the same as for normally threading the machine (for a single needle). See page 14 for more details.

- 6 Thread the right needle from front to back.**
Do not pass the thread behind the needle bar thread guide.

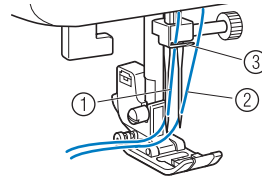

- ① Left needle thread passes through the needle bar thread guide.
- ② Right needle thread passes in front of the needle bar thread guide.
- ③ Needle bar thread guide

Note

Models equipped with a needle threader

- You cannot use the needle threader to thread the twin needle. Instead, thread the twin needle by hand, from front to back. Using the needle threader may damage the machine.

CAUTION

- When using the twin needle, be sure to attach zigzag foot “J”, otherwise the needle may break or the machine may be damaged.



REPLACING THE PRESSER FOOT

⚠ CAUTION

- Always turn off the power before you change the presser foot. If you leave the power on and step on the controller, the machine will start and you may be injured.
- Always use the correct presser foot for the stitch pattern you have chosen. If you use the wrong presser foot, the needle may strike the presser foot and bend or break, and may cause injury.
- Only use presser feet that have been designed to be used with this machine. Using other any presser feet may cause an accident or injury.

Replacing the presser foot

Replace the presser foot as described below.

- 1 Raise the needle by turning the handwheel toward you (counterclockwise) so that the mark on the wheel points up. (With models equipped with , raise the needle by pressing  once or twice.)

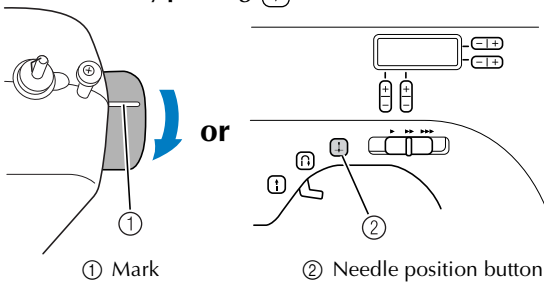

- 2 If the sewing machine has been turned on, turn it off.

⚠ CAUTION

- Before replacing the presser foot, be sure to turn off the sewing machine, otherwise injuries may occur if the foot controller or the start/stop button is accidentally pressed and the machine starts sewing.

- 3 Raise the presser foot lever.

- 4 Press the black button release the presser foot.

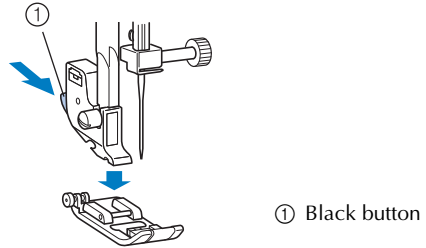

- 5 Place a different presser foot below the holder so that the presser foot pin is aligned with the shank in the holder.
Position the presser foot so the letter indicating the presser foot type (J, A, etc.) is positioned to be read.

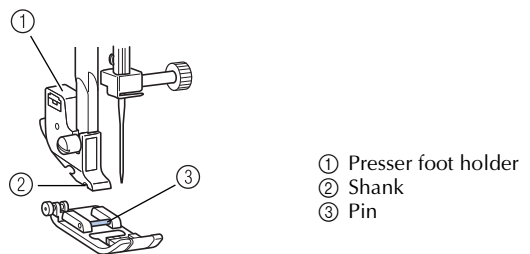

⚡ Note

- The presser foot to be used with each stitch appears in the LCD. To select a stitch, refer to "Selecting stitching" (page 22).

- 6 Slowly lower the presser foot lever so that the presser foot pin snaps into the shank.

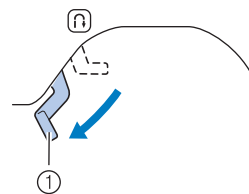

- ▶ The presser foot is attached.

- 7 Raise the presser foot lever to check that the presser foot is securely attached.

Removing the presser foot holder

Remove the presser foot holder when cleaning the sewing machine or when installing a presser foot that does not use the presser foot holder, such as the quilting foot. Use the disc-shaped screwdriver to remove the presser foot holder.

■ Removing the presser foot holder

- 1 Remove the presser foot. (Refer to page 20.)
- 2 Loosen the presser foot holder screw.

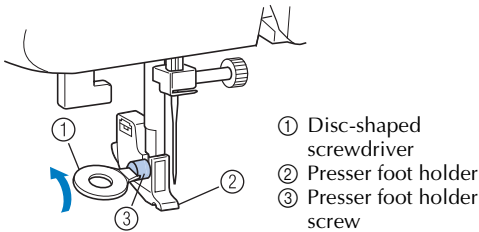

■ Attaching the presser foot holder

- 1 Align the presser foot holder with the lower-left side of the presser bar.

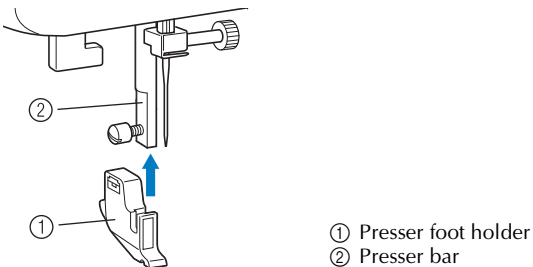

- 2 Holding the presser foot holder in place, tighten the screw.

⚡ Note

- If the presser foot holder is not correctly installed, the thread tension will be incorrect.

2 SEWING BASICS

SEWING

Basic sewing operations are described below. Before operating the sewing machine, read the following precautions.

⚠ CAUTION

- While the machine is in operation, pay special attention to the needle location. In addition, keep your hands away from all moving parts such as the needle and handwheel, otherwise injuries may occur.
- Do not pull or push the fabric too hard while sewing, otherwise injuries may occur or the needle may break.
- Never use bent needles. Bent needles can easily break, possibly resulting in injuries.
- Make sure that the needle does not strike basting pins, otherwise the needle may break or bend.

General sewing procedure

Follow the basic procedures below to sew.

1 Turn on the machine.

Turn on the sewing machine. For details on turning on the machine, refer to "Power supply" (page 7).



2 Select the stitch.

Select the stitch appropriate for the area to be sewn. For details on selecting a stitch, refer to "Selecting stitching" (page 22).



3 Attach the presser foot.

Attach the presser foot appropriate for the stitch. For details on replacing the presser foot, refer to "Replacing the presser foot" (page 20).



4 Start sewing.

Position the fabric, and then start sewing. When sewing is finished, cut the threads. For details on starting to sew, refer to "Starting to sew" (page 23).

ADJUSTING THE STITCH LENGTH AND WIDTH

Selecting stitching

Using the stitch selection keys, select the desired stitch. When the sewing machine is turned on, the straight stitch (left needle position) is selected.

1 Turn on the sewing machine.

2 Press (stitch selection keys). The number of the selected stitch is displayed.

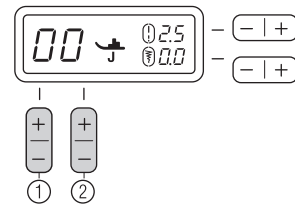

- ① Designate the tens digit.
- ② Designate the ones digit.
- ▶ The stitch is selected.

3 Attach the presser foot indicated in the LCD.

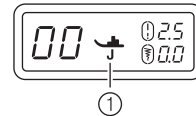

- ① Presser foot type.

For details, refer to "Replacing the presser foot" (page 20).

■ [Example] Selecting stitch

1 Press the stitch selection keys to select stitch 04.

With on the right, select "4", and with on the left, select "0".

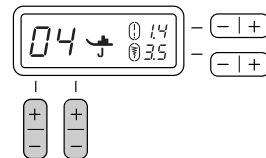

- 2** Press the “+” or “-” side of $\ominus|+$ (stitch length adjustment key) to increase or reduce the stitch length.

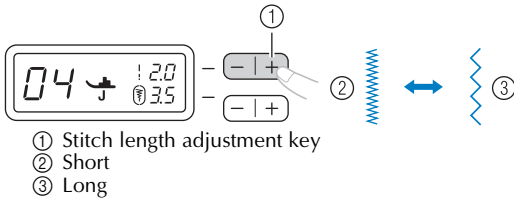

- 3** Press the “+” or “-” side of $\ominus|+$ (stitch width adjustment key) to increase or reduce the stitch width.

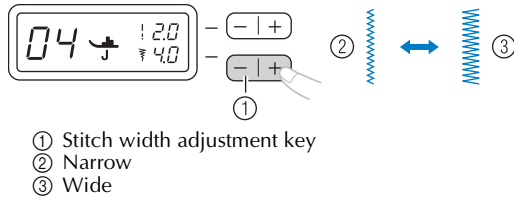

Note

- When the stitch length or stitch width is changed from the standard setting, \circlearrowleft around \updownarrow or ⌘ disappears from the LCD.
- If the stitch width of the selected stitch cannot be adjusted, “--” appears to the right of ⌘ in the LCD.

CAUTION

- After adjusting the stitch width, slowly turn the handwheel toward you (counterclockwise) and check that the needle does not touch the presser foot. If the needle hits the presser foot, the needle may bend or break.
- If the stitches are bunched together, increase the stitch length. Continuing to sew with the stitches bunched together may result in the needle bending or breaking.

Starting to sew

- 1** Raise the needle by turning the handwheel toward you (counterclockwise) so that the mark on the wheel points up. (With models equipped with \updownarrow (needle position button), raise the needle by pressing \updownarrow once or twice.)

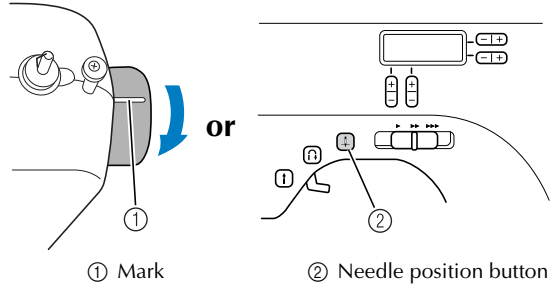

- 2** Raise the presser foot lever.

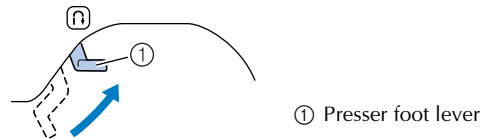

- 3** Place the fabric under the presser foot, pass the thread under the presser foot, and then pull out about 5 cm (2 inch) of thread toward the rear of the machine.

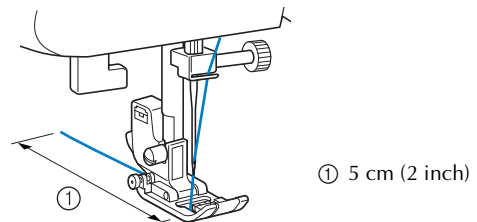

- 4** While holding the end of the thread and the fabric with your left hand, turn the handwheel toward you (counterclockwise) with your right hand to lower the needle to the starting point of the stitching.

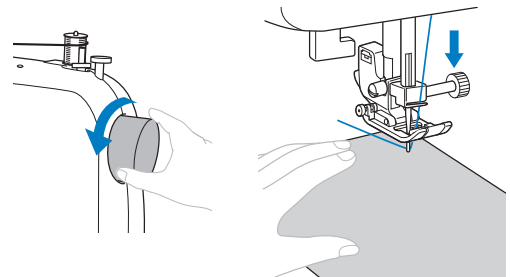

- 5** Lower the presser foot lever.

- 6** On models equipped with a sewing speed controller, slide the sewing speed controller to the left or right to adjust the sewing speed. Refer to “Sewing speed controller” (page 8).

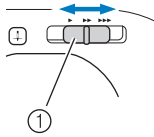

① Sewing speed controller

- 7** Slowly press down on the foot controller. (With models equipped with (start/stop button), if the foot controller is not connected, press once.)

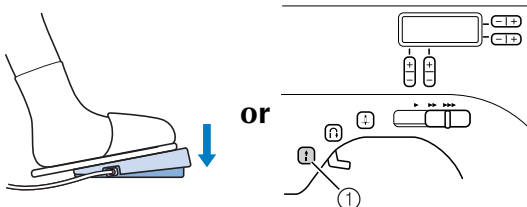

① Start/stop button

► The machine starts sewing.

- 8** Take your foot off the foot controller, or press (start/stop button) once (if the machine was started by pressing (start/stop button)) (for models equipped with the start/stop button).

► The machine stops sewing.

- 9** Raise the needle by turning the handwheel toward you (counterclockwise) so that the mark on the wheel points up. (With models equipped with (needle position button), raise the needle by pressing once or twice.)

- 10** Raise the presser foot lever.

- 11** Pull the fabric to the left side of the machine, and then cut the threads by using the thread cutter.

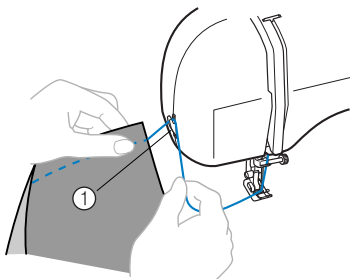

① Thread cutter

Memo

- When the foot controller is plugged in, (start/stop button) cannot be used to start or stop sewing.
- When sewing is stopped, the needle remains lowered (in the fabric). The machine can be set so that the needle will stay up when sewing is stopped. For details on setting the machine so that the needles stay up when sewing is stopped, refer to “Changing the needle stop position” (page 8).

■ Sewing reinforcement stitches

When sewing stitches other than straight or zigzag stitches that are secured with reverse stitching, pressing (reverse/reinforcement stitch button) sews reinforcement stitches, 3 to 5 stitches on top of each other.



①



②

① Reverse stitching

② Reinforcement stitching

Memo

- Whether reverse stitches or reinforcement stitches are sewn depends on the stitch that is selected. For details, refer to “Stitch settings” (page 45).

Thread tension

The thread tension will affect the quality of your stitches. You may need to adjust it when you change fabric or thread.

Memo

- We recommend that you do a test sample on scrap of a fabric before you start to sew.

■ Correct tension

Correct tension is important as too much or too little tension will weaken your seams or cause puckers on your fabric.

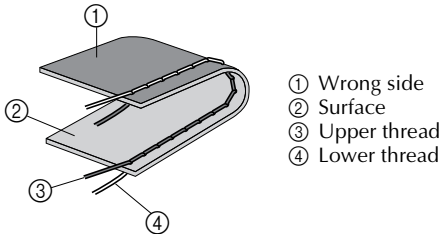

■ Upper tension is too tight

Loops will appear on the surface of the fabric.

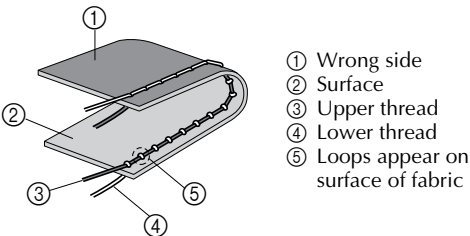

Solution

Reduce the tension by turning the upper tension-control dial to a lower number.

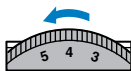

■ Upper tension is too loose

Loops appear on the wrong side of the fabric.

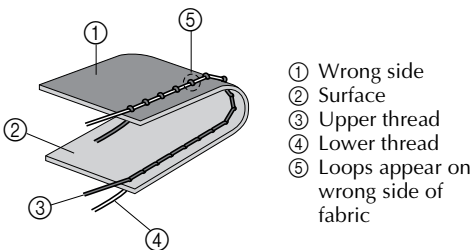

Solution

Increase the tension by turning the upper tension-control dial to a higher number.

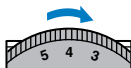

USEFUL SEWING TIPS

Various ways to achieve better results for your sewing projects are described below. Refer to these tips when sewing your project.

Trial sewing

A trial piece of fabric should be sewn. Use a piece of fabric and thread that are the same as those used for your project, and check the thread tension and stitch length and width.

Changing the sewing direction

1 When the stitching reaches a corner, stop the sewing machine.

Leave the needle lowered (in the fabric). If the needle was raised, lower the needle either by turning the handwheel toward you (counterclockwise) or by pressing  (needle position button) once (for models equipped with the needle position button).

CAUTION

- When using the twin needle, be sure to raise the needle before changing the sewing direction. If the fabric is turned while the needle is lowered, the needle may bend or break.

2 Raise the presser foot lever, and then turn the fabric.

Turn the fabric using the needle as a pivot.

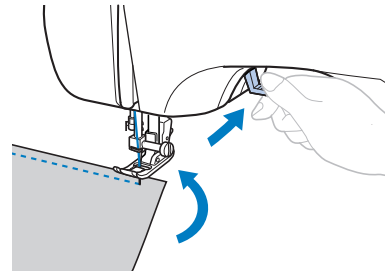

3 Lower the presser foot lever and continue sewing.

Sewing curves

Stop sewing, and then slightly change the sewing direction to sew around the curve.

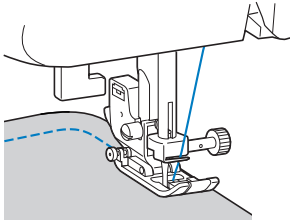

When sewing along a curve while using a zigzag stitch, select a shorter stitch length in order to obtain a finer stitch.

Sewing thick fabrics

- **If the fabric does not fit under the presser foot**
If the fabric does not fit easily under the presser foot, raise the presser foot lever even higher to bring the presser foot to its highest position.
- **If thick seams are being sewn and the fabric does not feed at the beginning of stitching**
Zigzag foot "J" is equipped with a feature that keeps the presser foot level.

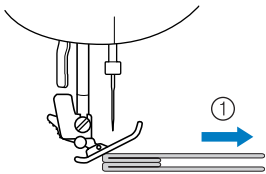

① Sewing direction

- 1** When you encounter a seam that is too thick to feed under the foot, raise the presser foot lever.
- 2** Press the black button on the left side of the foot. Keep the button held in and lower the presser foot.

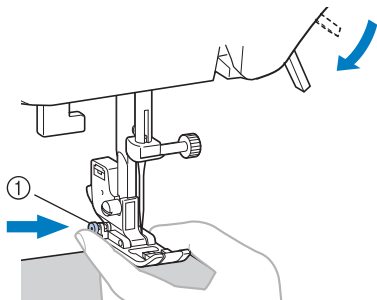

① Black button

- 3** Release the button. The foot will lock in place level with the seam, allowing the fabric to feed.

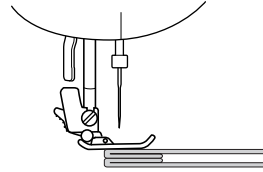

- Once the trouble spot has been passed, the foot will return to its normal position.

CAUTION

- If fabric more than 6 mm (15/64 inch) thick is sewn or if the fabric is pushed with too much force, the needle may bend or break.

Sewing thin fabrics

When sewing thin fabrics, the stitching may become misaligned or the fabric may not feed correctly. If this occurs, place thin paper or stabilizer material under the fabric and sew it together with the fabric. When you have finished sewing, tear off any excess paper.

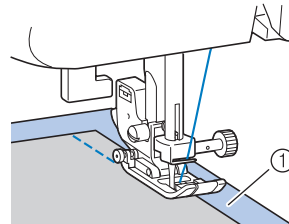

① Stabilizer material or paper

Sewing stretch fabrics

First, baste the pieces of fabric together, and then sew without stretching the fabric.

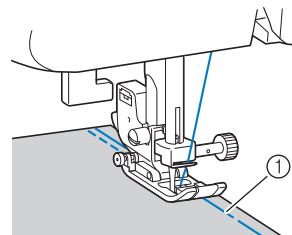

① Basting

Using a free-arm style

Free-arm sewing is convenient for sewing tubular and hard-to-reach areas. To change your machine to the free-arm style, lift out the flat bed attachment.

- 1 Slide the flat bed attachment to the left to release it.

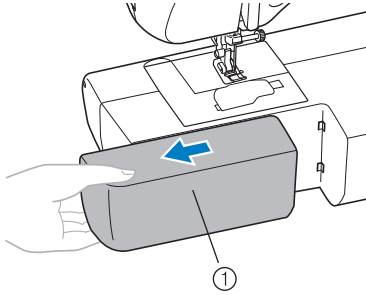





① Flat bed attachment

3 UTILITY STITCHES

OVERCASTING STITCHES

You can use the overcasting stitches to join together seams and finish them in one operation. They are also useful for sewing stretch materials.

Stitch Name	Pattern	Presser Foot	Pattern No.			
			70 stitches model	60 stitches model	50 stitches model	40 stitches model
Zigzag stitch		J	04	04	04	04
3-point zigzag stitch		J	05	05	05	05
Overcasting stitch		G	06	06	06	06
		G	07	07	07	07
		J	08	08	08	08

- 1 Attach overcasting foot "G" or zigzag foot "J".
- 2 Select a stitch.
 - For details, refer to "Selecting stitching" (page 22).
- 3 Position the fabric with the edge of the fabric against the guide of the presser foot, and then lower the presser foot lever.

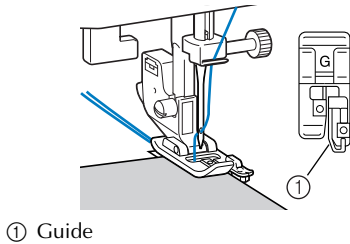

① Guide

- 4 Sew with the edge of the fabric against the presser foot guide.

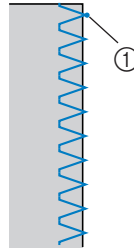



① Needle drop point

⚠ CAUTION

- After adjusting the stitch width, slowly turn the handwheel toward you (counterclockwise) and check that the needle does not touch the presser foot. If the needle hits the presser foot, the needle may bend or break.

BASIC STITCHING

Straight stitches are used for sewing plain seams.

Stitch Name	Pattern	Presser Foot	Pattern No.			
			70 stitches model	60 stitches model	50 stitches model	40 stitches model
Straight	Left 	J	00	00	00	00
	Center 	J	01	01	01	01
Triple stretch stitch 		J	02	02	02	02

Basic stitching

- 1 Baste or pin together the fabric pieces.
- 2 Attach zigzag foot "J".
- 3 Select a stitch.
 - For details, refer to "Selecting stitching" (page 22).
- 4 Lower the needle into the fabric at the beginning of the stitching.

5 Start sewing.

- For details, refer to “Starting to sew” (page 23).
- For details on sewing reverse/reinforcement stitches, refer to “Sewing reinforcement stitches” (page 24).

6 When sewing is finished, cut the thread.

- For details, refer to “Starting to sew” (page 23).

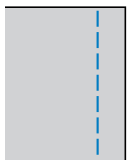

Changing the needle position

With the straight stitch (left needle position) and the triple stretch stitch, the needle position can be adjusted. Pressing the “+” side of the stitch width adjustment key moves the needle to the right; pressing the “-” side of the stitch width adjustment key moves the needle to the left.

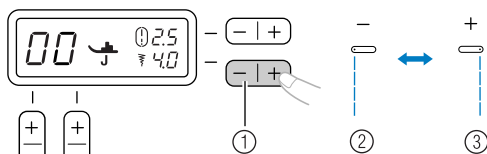

- ① Stitch width adjustment key
- ② Left needle position
- ③ Right needle position

BLIND HEM STITCHING

You can use the Blind Hem Stitch to finish the edge of a project, like the hem of a pair of trousers, without the stitch showing.

Stitch Name	Pattern	Presser Foot	Pattern No.			
			70 stitches model	60 stitches model	50 stitches model	40 stitches model
Blind hem stitch		R	09	09	09	09
		R	10	10	10	10

1 Fold the fabric along the desired edge of the hem, and then baste it about 5 mm (3/16 inch) from the edge of the fabric. Fold back the fabric along the basting, and then position the fabric with the wrong side facing up.

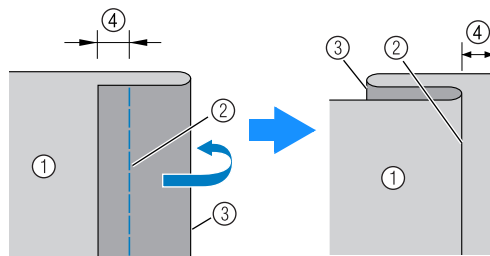

- ① Wrong side of fabric
- ② Basting
- ③ Desired edge of hem
- ④ 5 mm (3/16 inch)

2 Attach blind hem foot “R”.

3 Select a stitch.

4 Position the fabric with the edge of the folded hem against the guide of the presser foot, and then lower the presser foot lever.

Check that the needle slightly catches the fold of the hem.

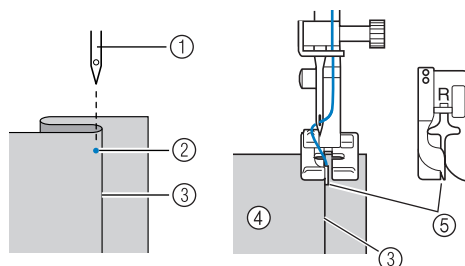

- ① Needle
- ② Needle drop point
- ③ Fold of hem
- ④ Wrong side of fabric
- ⑤ Guide

If the needle catches too much of the hem fold

If the needle catches too much of the hem fold, adjust the stitch width so that the needle slightly catches the fold by pressing the “+” side of the stitch width adjustment key.

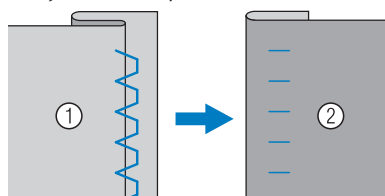

- ① Wrong side of fabric
- ② Right side of fabric

■ If the needle does not catch the hem fold

If the needle does not catch the hem fold, adjust the stitch width so that the needle slightly catches the fold by pressing the “-” side of the stitch width adjustment key.

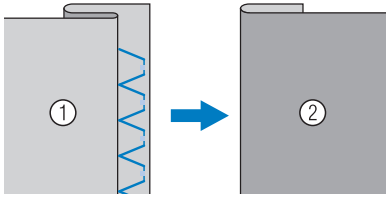

① Wrong side of fabric ② Right side of fabric

- For details on changing the stitch width, refer to “Selecting stitching” (page 22).

5 Sew with the fold of the hem against the presser foot guide.

6 Remove the basting stitching and turn the fabric right side up.

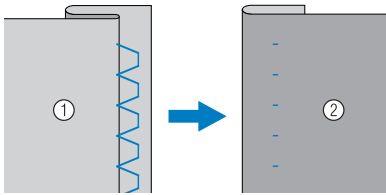

① Wrong side of fabric ② Right side of fabric

BUTTONHOLE SEWING

Buttonholes can be sewn and buttons can be sewn on.

Stitch Name	Pattern	Presser Foot	Pattern No.			
			70 stitches model	60 stitches model	50 stitches model	40 stitches model
Buttonhole stitch		A	29	29	29	25
		A	30	30	30	26
		A	31	31	31	27
		A	32	32	32	28
		A	33	33	33	29
		A	34	34	-	-
		A	35	35	-	-

Zigzag stitch (for quilting)		J	40	40	-	-
------------------------------	--	---	----	----	---	---

The maximum buttonhole length is about 28 mm (1-1/8 inch) (diameter + thickness of the button).

Buttonholes are sewn from the front of the presser foot to the back, as shown below.

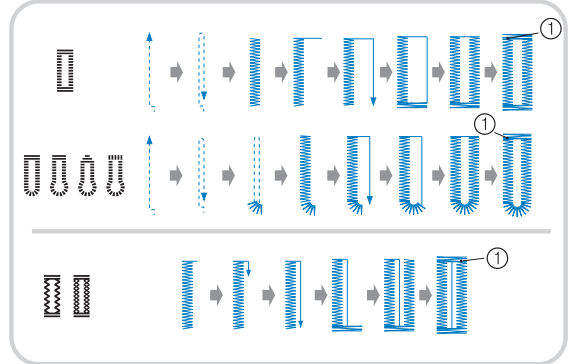

① Reinforcement stitching

■ Part names of the buttonhole foot “A”

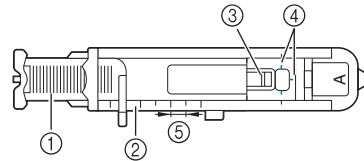

- ① Button guide plate
- ② Presser foot scale
- ③ Pin
- ④ Marks on buttonhole foot
- ⑤ 5 mm (3/16 inch)

1 Use chalk to mark the position and length of the buttonhole on the fabric.

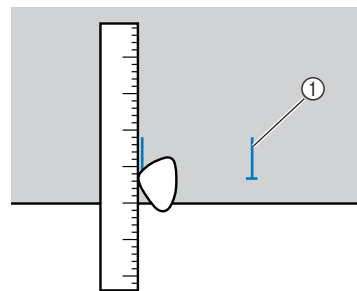

① Marks on fabric

- 2** Pull out the button guide plate of buttonhole foot “A”, and then insert the button that will be put through the buttonhole.

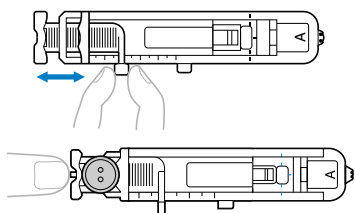

► The size of the buttonhole is set.

■ If the button does not fit in the button guide plate

Add together the diameter and thickness of the button, and then set the button guide plate to the calculated length. (The distance between the markings on the presser foot scale is 5 mm (3/16 inch).)

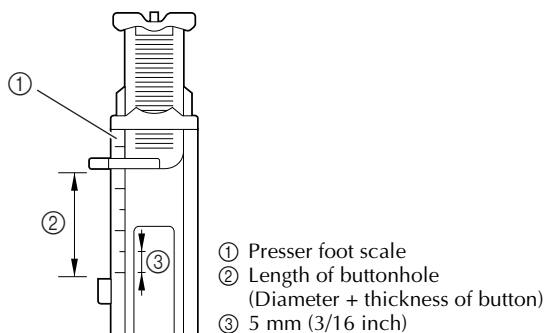

Example: For a button with a diameter of 15 mm (9/16 inch) and a thickness of 10 mm (3/8 inch), the button guide plate should be set to 25 mm (1 inch) on the scale.

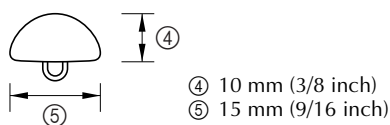

- 3** Attach buttonhole foot “A”.

- 4** Select a stitch.

- 5** Position the fabric with the front end of the buttonhole mark aligned with the red marks on the sides of the buttonhole foot, and then lower the presser foot lever.

Pass the upper thread down through the hole in the presser foot.

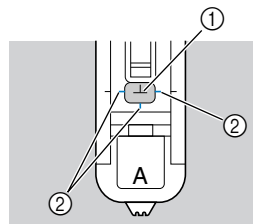

- ① Mark on fabric
② Red marks on buttonhole foot
- When lowering the presser foot, do not push in the front of the presser foot, otherwise the buttonhole will not be sewn with the correct size.

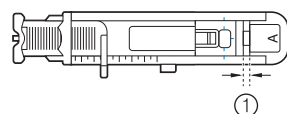
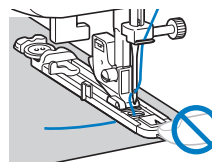

- ① Do not reduce the gap.

- 6** Pull down the buttonhole lever as far as possible.

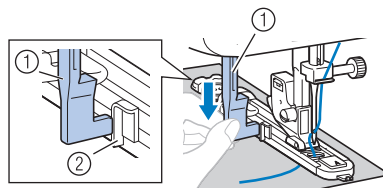

- ① Buttonhole lever
② Bracket

The buttonhole lever is positioned behind the bracket on the buttonhole foot.

- 7** Gently hold the end of the upper thread in your left hand, and then start sewing.

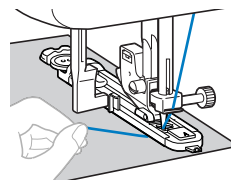

- Once sewing is completed, the machine automatically sews reinforcement stitches, then stops.

- 8 Raise the presser foot lever, remove the fabric, and cut the thread.
- 9 Raise the buttonhole lever to its original position.
- 10 Insert a pin at the end of the buttonhole stitching to prevent the stitching from being cut, and then use a seam ripper to cut towards the pin and open the buttonhole.

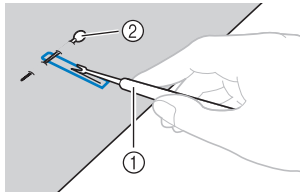

① Seam ripper
② Pin

For keyhole buttonholes, use a commercial eyelet punch to make a hole in the rounded end of the buttonhole, and then use the seam ripper to cut open the buttonhole.

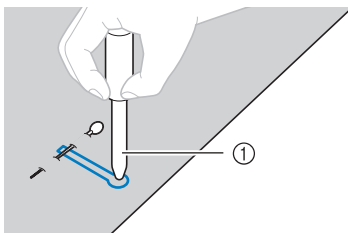

① Eyelet punch

- When using the eyelet punch, place thick paper or some other protective sheet under the fabric before punching the hole in the fabric.

⚠ CAUTION

- When opening the buttonhole with the seam ripper, do not place your hands in the cutting direction, otherwise injuries may result if the seam ripper slips.

🔔 Memo



- Before sewing buttonholes, check the stitch length and width by sewing a trial buttonhole on a scrap piece of fabric.

- Sewing buttonholes on stretch fabrics
When sewing buttonholes on stretch fabrics, use a gimp thread.

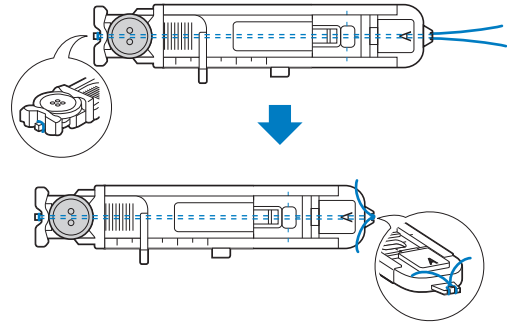
- 1 Hook the gimp thread onto the part of buttonhole foot “A” shown in the illustration so that it fits into the grooves, and then loosely tie it.



- 2 Attach buttonhole foot “A”.

- 3 Select a stitch  or .

- 4 Adjust the stitch width to the thickness of the gimp thread.

- 5 Lower the presser foot lever and the buttonhole lever, and then start sewing.

- 6 When sewing is finished, gently pull the gimp thread to remove any slack.

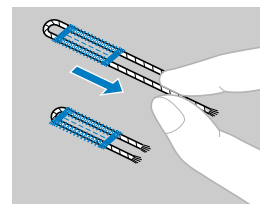

- 7 Use a handsewing needle to pull the gimp thread to the wrong side of the fabric, and then tie it.

- 8 With a seam ripper, cut the middle part of the gimp thread remaining at the top end of the buttonhole.
Trim off any excess of the gimp thread.

Button sewing

Buttons can be sewn on with the sewing machine. Buttons with 2 or with 4 holes can be attached.

- 1 Measure the distance between the holes.

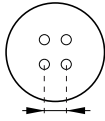

- 2 Raise the presser foot lever, and then slide the feed dog position lever, located at the rear of the machine on the base, to .

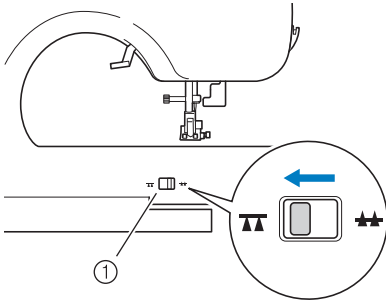

① Feed dog position lever

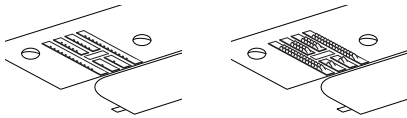

► The feed dogs are lowered.

- 3 Attach presser foot "M".

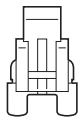

- 4 Place a button between the presser foot and the fabric.

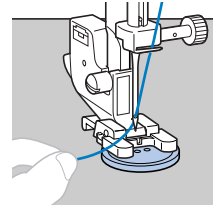

- When attaching four-hole buttons, first sew the two holes closest to you. Then, slide the button so that the needle goes into the two holes, and then sew them in the same way.

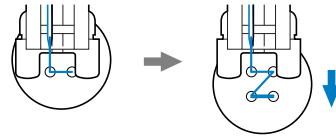

- 5 Select a stitch . (With models not provided with stitch , select stitch .)

- 6 Adjust the stitch width so that it is the same as the distance between the holes in the button.

- 7 Set the stitch length to the shortest setting by pressing the stitch length adjustment key.

- 8 Turn the handwheel toward you (counterclockwise) to check that the needle correctly goes into the two holes of the button. Adjust the stitch width to the distance between the button holes.

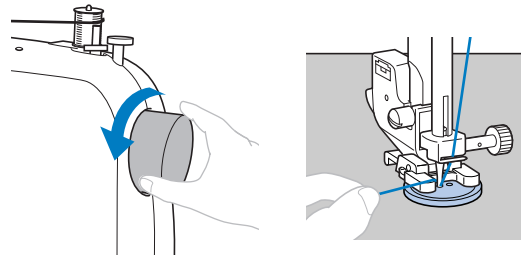

⚠ CAUTION

- When sewing, be sure that the needle does not touch the button, otherwise the needle may bend or break.

- 9 Start sewing.

- After sewing for about 10 seconds at low speed, press (reverse/reinforcement stitch button) to sew reinforcement stitches.

- 10** Pull the upper thread at the end of the stitching to the wrong side of the fabric, and then tie it with the bobbin thread.

Use scissors to cut the upper thread and the bobbin thread at the beginning of the stitching.

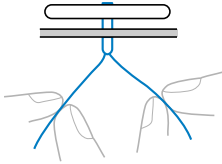

- 11** When you are finished attaching the button, slide the feed dog position lever to to raise the feed dogs.

ZIPPER INSERTION

You can use the zipper foot to sew different types of zippers, and can easily position it to the right or left side of the needle.

When sewing the right side of the zipper, attach the shank to the left pin of the zipper foot. When sewing the left side of the zipper, attach the shank to the right pin of the zipper foot.

Stitch Name	Pattern	Presser Foot	Pattern No.			
			70 stitches model	60 stitches model	50 stitches model	40 stitches model
Straight stitch (center)		1	01	01	01	01

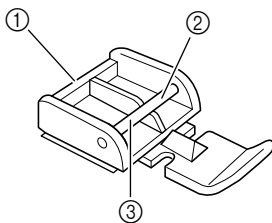

- ① Zipper foot
 ② Right pin for sewing the left side of the zipper
 ③ Left pin for sewing the right side of the zipper

- 1** Select stitch .
- 2** Lower the presser foot lever and fix either the left or right pin of the zipper foot onto the shank.
- 3** Fold the edge of the material 2 cm (3/4 inch) and place the zipper under the folded section. Lower the needle into the notch located either on the left or right side of the zipper foot.

CAUTION

- Turn the handwheel by hand to make sure the needle does not hit the presser foot before you start sewing. If you choose a different stitch, the needle will hit the presser foot and break the needle. You may also be injured.

- 4** Sew from the bottom of the zipper toward the top on both sides. The needle should be positioned on the zipper side of the foot for best results.

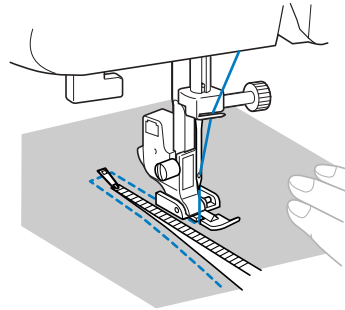



- 5** To sew the opposite side of the zipper, release the foot by pressing the button located at the back of the presser foot, fit the zipper foot on the other side of the zipper and continue sewing using the other side notch.

CAUTION

- Make sure the needle does not hit the zipper during sewing. If the needle hits the zipper, the needle may break and you may be injured.

SEWING STRETCH FABRICS AND ELASTIC TAPE

Stretch fabrics can be sewn and elastic tape can be attached.

Stitch Name	Pattern	Presser Foot	Pattern No.			
			70 stitches model	60 stitches model	50 stitches model	40 stitches model
Stretch stitch		J	03	03	03	03
3-point zigzag stitch		J	05	05	05	05

Observe the corresponding precautions when performing each of the following stitching operations.

Stretch stitching

- 1 Attach zigzag foot "J".
- 2 Select stitch .
- 3 Sew the fabric without stretching it.

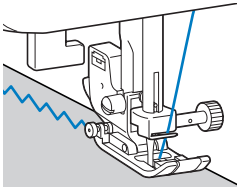

Elastic attaching

When elastic tape is attached to the cuff or waist of a piece of clothing, the finished dimensions will be that of the stretched elastic tape. Therefore, it is necessary that a suitable length of the elastic tape be used.

- 1 Pin the elastic tape to the wrong side of the fabric.
Pin the elastic tape to the fabric at a few points to make sure that the tape is uniformly positioned on the fabric.

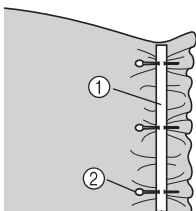

- ① Elastic tape
- ② Pin

- 2 Attach zigzag foot "J".

- 3 Select stitch .

- 4 Sew the elastic tape to the fabric while stretching the tape so that it is the same length as the fabric.

While pulling the fabric behind the presser foot with your left hand, pull the fabric at the pin nearest the front of the presser foot with your right hand.

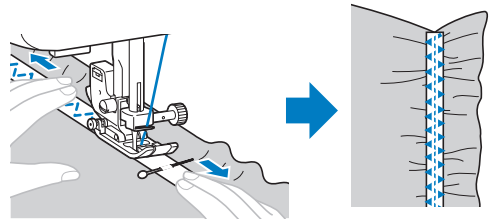

CAUTION

- When sewing, be sure that the needle does not touch any pins, otherwise the needle may bend or break.

APPLIQUÉ, PATCHWORK AND QUILT STITCHING

The stitches that can be used for sewing appliqué, patchwork and quilts are described below.

Stitch Name	Pattern	Presser Foot	Pattern No.			
			70 stitches model	60 stitches model	50 stitches model	40 stitches model
Zigzag stitch		J	04	04	04	04
Zigzag stitch (for quilting)		J	40	40	-	-
Appliqué stitch		J	11	11	11	11
Appliqué stitch (for quilting)		J	41	41	-	-
		J	42	42	-	-
Piecing straight stitch		J	37	37	-	-
		J	38	38	-	-
Joining stitch		J	14	14	14	14
		J	15	15	15	15
		J	16	16	16	16
Hand-look quilting		J	39	39	35	31
Quilting stippling		J	43	43	-	-

Appliqués

You can create an appliqué by cutting a different piece of fabric into a shape and using it as a decoration.

- 1 Baste the cut design to the fabric.
- 2 Attach zigzag foot "J".

- 3 Select stitch
- 4 Carefully sew around the edge of the design. Cut away any fabric that is left outside the stitching.

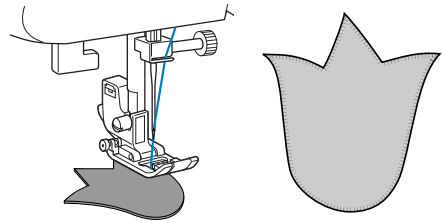

- 5 Remove the basting, if necessary.

Memo

- Make reinforcing straight stitches at the beginning and the end of stitching.

CAUTION

- Be careful that the needle does not hit a pin during sewing, as the needle can break. You may also be injured.

Patchwork (crazy quilt) stitching

- 1 Fold the edge of the top piece of fabric and place it over the lower piece.
- 2 Sew the two pieces of fabric together so the pattern spans both pieces.

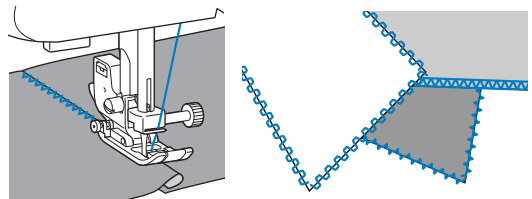

Piecing

Sewing together two pieces of fabric is called “piecing”. The fabric pieces should be cut with a 6.5 mm (1/4 inch) seam allowance.

Sew a piecing straight stitch 6.5 mm (1/4 inch) from either the right side or the left side of the presser foot.

1 Baste or pin along the seam allowance of the fabric that you wish to piece together.

2 Attach zigzag foot “J”.

3 Select stitch  or .

4 Sew with the side of the presser foot aligned with the edge of the fabric.

■ For a seam allowance on the right side

Align the right side of the presser foot with the edge of the fabric, and sew using stitch .

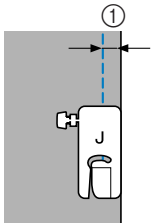

① 6.5 mm (1/4 inch)

① 6.5 mm (1/4 inch)

■ For a seam allowance on the left side

Align the left side of the presser foot with the edge of the fabric, and sew using stitch .

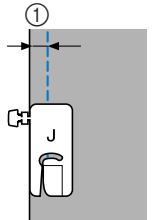

① 6.5 mm (1/4 inch)

① 6.5 mm (1/4 inch)

Memo

- To change the width of the seam allowance (the needle position), adjust the stitch width. For details, refer to “Changing the needle position” (page 29).

Quilting

Sandwiching batting between the top and bottom layers of fabric is called “quilting”. Quilts can easily be sewn using the optional walking foot and the optional quilting guide.

Note

- Only use the walking foot with straight or zigzag stitches. Do not use other patterns. Reverse stitches cannot be sewn with the walking foot.

1 Baste the fabric to be quilted.

2 Remove the presser foot and the presser foot holder.

- For details, refer to “Removing the presser foot holder” (page 21).

3 Hook the connecting fork of the walking foot onto the needle clamp screw, lower the presser foot lever, and then use the presser foot holder screw to attach the walking foot to the presser bar.

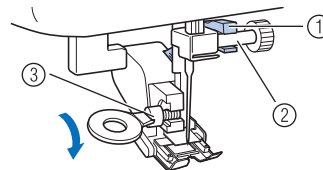

- ① Connecting fork
- ② Needle clamp screw
- ③ Presser foot holder screw

CAUTION

- Use the disc-shaped screwdriver to tighten the screw securely. If the screw is loose, the needle may strike the presser foot and cause injury.
- Be sure to turn the handwheel toward the front of the machine to check that the needle does not strike the presser foot. If the needle strikes the presser foot, injury may result.

4 Select stitch ,  or .

- 5** Place one hand on each side of the presser foot, and then evenly guide the fabric while sewing.

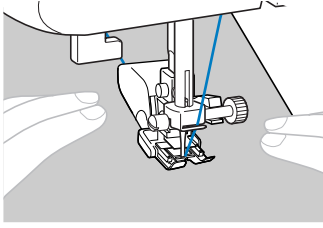

Note

- When sewing with the walking foot, sew at a speed between slow and medium.

Using the optional quilting guide

Use the quilting guide to sew parallel stitches that are equally spaced.

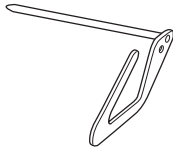

- 1** Insert the stem of the quilting guide into the hole at the rear of the walking foot or presser foot holder.

- Walking foot
- Presser foot holder

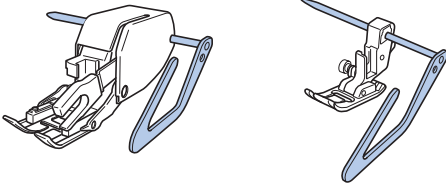

- 2** Adjust the stem of the quilting guide so that the quilt guide aligns with the seam that has already been sewn.

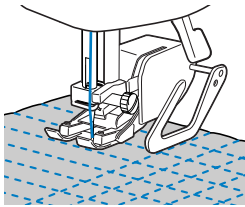

Free-motion quilting

With free-motion quilting, the feed dogs can be lowered (using the feed dog position lever) so that the fabric can be moved freely in any direction.

The optional quilting foot is needed for free-motion quilting.

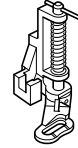

- 1** Remove the presser foot and the presser foot holder.

- For details, refer to “Removing the presser foot holder” (page 21).

- 2** Align the quilting foot with the lower-left side of the presser bar.

The pin on the quilting foot should be positioned over the needle clamp screw.

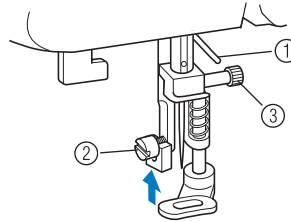

- ① Pin on quilting foot
- ② Presser foot holder screw
- ③ Needle clamp screw

- 3** Hold the quilting foot in place with your right hand, and then tighten the presser foot holder screw using the disc-shaped screwdriver in your left hand.

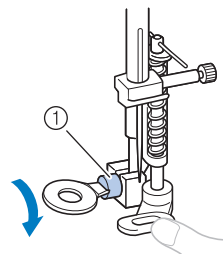

- ① Presser foot holder screw

CAUTION

- Be sure to securely tighten the screws with the disc-shaped screwdriver, otherwise the needle may touch the presser foot, causing it to bend or break.

- 4** Slide the feed dog position lever, to .

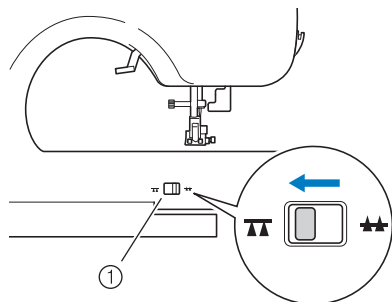

① Feed dog position lever

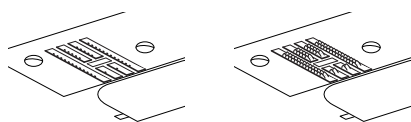

► The feed dogs are lowered.

- 5** Turn on the sewing machine, and then select a stitch.

- 6** Use both hands to hold the fabric taut, then move the fabric to follow the pattern.
Reinforcement stitches are sewn at the beginning and end of sewing.

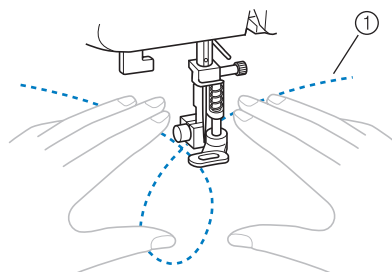



① Pattern

- 7** After sewing is finished, slide the feed dog position lever to  to raise the feed dogs.

- Normally, the feed dog position lever is positioned at .

REINFORCEMENT STITCHING

Reinforce points that will be subject to strain, such as sleeve holes, inseams and pocket corners.

Stitch Name	Pattern	Presser Foot	Pattern No.			
			70 stitches model	60 stitches model	50 stitches model	40 stitches model
Triple stretch stitch		J	02	02	02	02
Bar tack stitch		A	36	36	34	30

Triple stretch stitching

Use triple stretch stitching to reinforce sleeve holes and inseams.

- 1** Attach zigzag foot “J”.

- 2** Select stitch .

- 3** Start sewing.

- For details, refer to “Starting to sew” (page 23).

Bar tack stitching

Bar tacks are used to reinforce points subject to strain, such as pocket corners and openings.

As an example, the procedure for sewing bar tacks at pocket corners is described below.

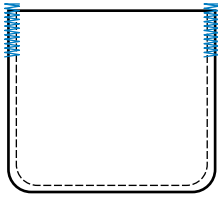

- 1 Determine the desired length of the bar tack.** Set the button guide plate on buttonhole foot “A” to the desired length. (The distance between the markings on the presser foot scale is 5 mm (3/16 inch).)

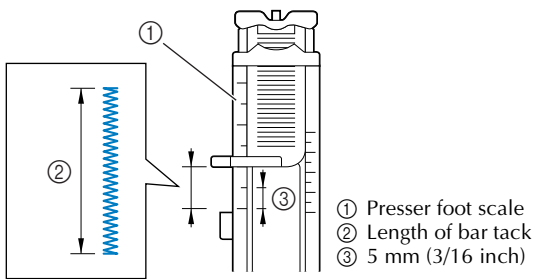

- A bar tack with a maximum length of about 28 mm (1-1/8 inch) can be sewn.

- 2 Attach buttonhole foot “A”.**

- 3 Select stitch** .

- 4 Position the fabric so that the opening of the pocket faces toward you, and then lower the presser foot lever so that the needle drops 2 mm (1/16 inch) in front of the pocket opening.**

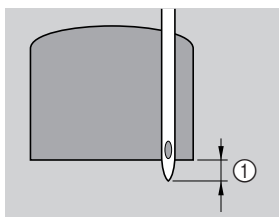

Pass the upper thread down through the hole in the presser foot.

- When lowering the presser foot, do not push in the front of the presser foot, otherwise the bar tack will not be sewn with the correct size.

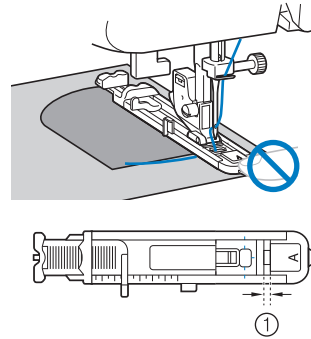

- ① Do not reduce the gap.

- 5 Pull down the buttonhole lever as far as possible.**

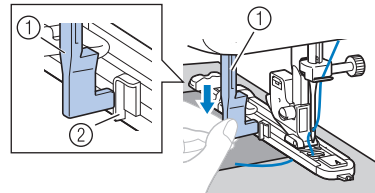

- ① Buttonhole lever
② Bracket

The buttonhole lever is positioned behind the bracket on the buttonhole foot.

- 6 Gently hold the end of the upper thread in your left hand, and then start sewing.**

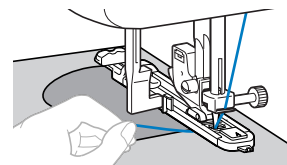

- Once sewing is completed, the machine automatically sews reinforcement stitches, then stops.

- 7 Raise the presser foot lever, remove the fabric, and cut the thread.**

















- 8 Raise the buttonhole lever to its original position.**

Memo

- If the fabric does not feed, for example, because it is too thick, increase the stitch length. For details, refer to “Selecting stitching” (page 22).

DECORATIVE STITCHING

Various decorative stitches can be sewn with this sewing machine.

Stitch Name	Pattern	Presser Foot	Pattern No.			
			70 stitches model	60 stitches model	50 stitches model	40 stitches model
Fagoting stitch		J	17	17	17	17
		J	18	18	18	18
Joining stitch		J	14	14	14	14
		J	15	15	15	15
		J	16	16	16	16
Shell tuck stitch		J	12	12	12	12
Satin scallop stitch		N	13	13	13	13
Decorative stitch		J	19	19	19	19
		J	20	20	20	20
		J	21	21	21	-
		N	22	22	22	21
		N	23	23	23	22
		N	24	24	24	23
		N	25	25	25	-
		N	26	26	26	24
		N	27	27	27	-

Decorative stitch		N	28	28	28	-
-------------------	---	---	----	----	----	---



Fagoting

Stitching across an open seam is called “fagoting”. It is used on blouses and children’s clothing. This stitch is more decorative when thicker thread is used.

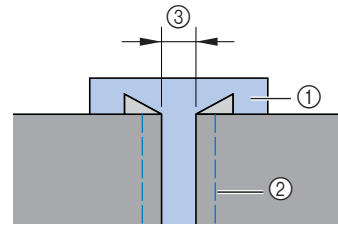
- 1 Use an iron to fold the two pieces of fabric along their seams.
- 2 Baste the two pieces of fabric, separated by about 4.0 mm (3/16 inch), onto thin paper or a sheet of water-soluble stabilizer.



- ① Thin paper or water soluble stabilizer
- ② Basting stitching
- ③ 4 mm (3/16 inch)

- 3 Attach zigzag foot “J”.
- 4 Select stitch  or .
- 5 Set the stitch width to 7.0 mm (1/4 inch).
 - For details, refer to “Selecting stitching” (page 22).
- 6 Sew with the center of the presser foot aligned along the center of the two pieces of fabric.

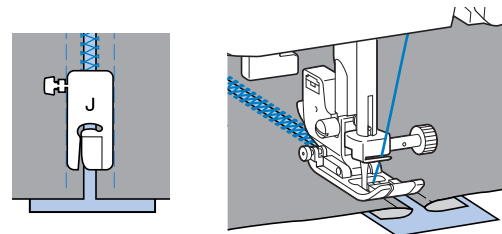

- 7 After sewing is finished, remove the paper.

3

Scallop stitching

The wave-shaped repeating pattern that looks like shells is called “scalloping”. It is used on the collars of blouses and to decorate the edges of handkerchiefs.

- 1 Attach monogramming foot “N”.
- 2 Select stitch .
- 3 Stitch along the edge of the fabric, making sure not to sew directly on the edge of the fabric.

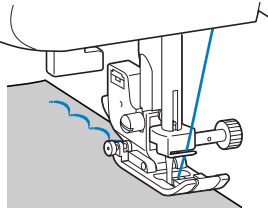

- For better results, apply spray starch onto the fabric and press with a hot iron before it is sewn.

- 4 Trim along the stitches.

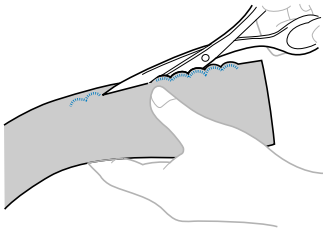

- Be careful not to cut the stitches.

Smocking

The decorative stitch created by stitching or embroidering over gathers is called “smocking”. It is used to decorate the front of blouses or cuffs.

The smocking stitch adds texture and elasticity to fabric.

- 1 Attach zigzag foot “J”.
- 2 Select the straight stitch, and then adjust the stitch length to 4.0 mm (3/16 inch) and loosen the thread tension.

- For details, refer to “Selecting stitching” (page 22) and “Thread tension” (page 25).

- 3 Sew parallel stitching at intervals of 1 cm (3/8 inch).

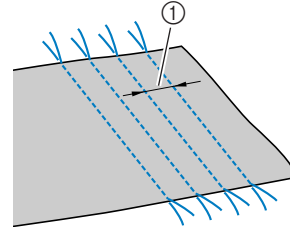



① 1 cm (3/8 inch)

- Do not sew reverse/reinforcement stitches or cut the thread.

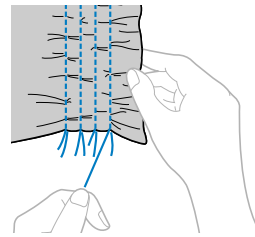
- 4 Pull the bobbin threads to create gathers. Smooth the gathers by ironing them.



- 5 Select stitch  or .

- 6 Stitch between the straight stitches.

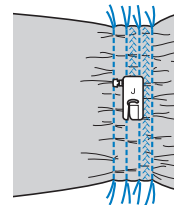

- 7 Pull out the threads for the straight stitches.

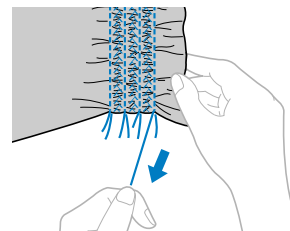

Shell tuck stitching

The gathers that look like shells are called “shell tucks”. They are used to decorate trims, the front of blouses or cuffs made of thin fabrics.

- 1 Fold the fabric along the bias.

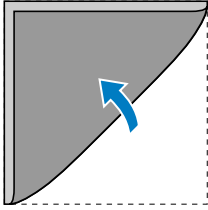

- 2 Attach zigzag foot “J”.

- 3 Select stitch , and then increase the thread tension.

- For details, refer to “Selecting stitching” (page 22).

- 4 Sew while making sure that the needle drops slightly off the edge of the fabric.

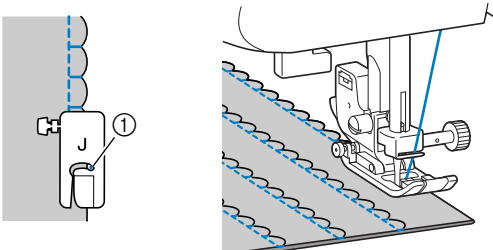

- ① Needle drop point

- 5 Unfold the fabric, and then iron the tucks down to one side.

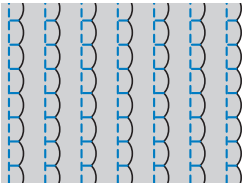

Joining

Decorative bridging stitches can be sewn over the seam allowance of joined fabrics. This is used when making a crazy quilt.

- 1 Attach zigzag foot “J”.

- 2 Sew together the right sides of the two pieces of fabric, and then open up the seam allowances.

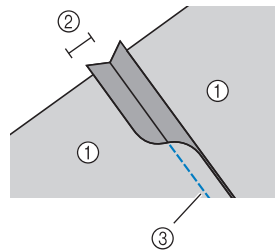

- ① Wrong side of fabric
② 6.5 mm (1/4 inch) seam allowance
③ Straight stitch

- 3 Select stitch ,  or .

- 4 Turn the fabric over so that the right side faces up, and then sew over the seam with the center of the presser foot aligned with the seam.

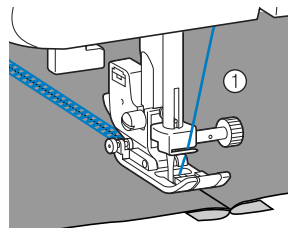

- ① Right side of fabric

Heirloom stitching

When sewing with the wing needle, the needle holes are enlarged, creating a lace-like decorative stitch. This is used to decorate hems and tablecloths on thin or medium weight fabrics in addition to plain weave fabrics.

⚠ CAUTION

- The needle threader cannot be used with the wing needle, otherwise the sewing machine may be damaged. Manually pass the thread through the eye of the needle from the front to the back. For details, refer to “Upper threading” (page 13).

- 1 Insert the wing needle.

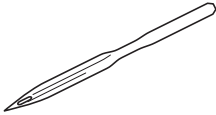

- Use a 130/705H 100/16 wing needle.
- For details on inserting a needle, refer to “Replacing the needle” (page 17).

- 2 Attach monogramming foot “N”.

- 3 Select stitch  or .

⚠ CAUTION

- Select a stitch width of 6.0 mm (15/64 inch) or less, otherwise the needle may bend or break.
- After adjusting the stitch width, slowly turn the handwheel toward you (counterclockwise) and check that the needle does not touch the presser foot. If the needle hits the presser foot, the needle may bend or break.

- 4 Start sewing.

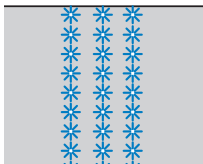

4 APPENDIX

STITCH SETTINGS

Applications, stitch lengths and widths and whether the twin needle can be used are listed for utility stitches in the following table.

⚠ CAUTION

- Select a stitch width of 5.0 mm (3/16 inch) or less, otherwise the needle may break or the machine may be damaged.
- When using the twin needle, be sure to attach zigzag foot “J”, otherwise the needle may break or the machine may be damaged.

















Utility stitches

Stitch Name	Pattern	Presser Foot	Pattern No.				Application	Stitch Width [mm (inch.)]		Stitch Length [mm (inch.)]		Twin Needle	Walking Foot	Reverse/Reinforcement Stitching	
			70 stitches model	60 stitches model	50 stitches model	40 stitches model		Auto	Manual	Auto	Manual				
Straight	Left		J	00	00	00	00	Basic stitching, sewing gathers or pintucks, etc.	0.0 (0)	0.0–7.0 (0–1/4)	2.5 (3/32)	0.2–5.0 (1/64–3/16)	No	Yes***	Rev. *
	Center		J	01	01	01	01	Attaching zippers, basic stitching, and sewing gathers or pintucks, etc.	–	–	2.5 (3/32)	0.2–5.0 (1/64–3/16)	Yes (J)	Yes***	Rev. *
Triple stretch stitch		J	02	02	02	02	Attaching sleeves, sewing inseams, sewing stretch fabrics and decorative stitching	0.0 (0)	0.0–7.0 (0–1/4)	2.5 (3/32)	1.5–4.0 (1/16–3/16)	No	No	Rfc. **	
Stretch stitch		J	03	03	03	03	Sewing stretch fabrics and decorative stitching	1.0 (1/16)	1.0–3.0 (1/16–1/8)	2.5 (3/32)	1.0–4.0 (1/16–3/16)	**** Yes (J)	No	Rfc. **	
Zigzag stitch		J	04	04	04	04	Overcasting and attaching appliques	3.5 (1/8)	0.0–7.0 (0–1/4)	1.4 (1/16)	0.0–4.0 (0–3/16)	**** Yes (J)	Yes***	Rev. *	
3-point zigzag stitch		J	05	05	05	05	Overcasting on medium weight or stretch fabrics, attaching elastic, darning, etc.	5.0 (3/16)	1.5–7.0 (1/16–1/4)	1.0 (1/16)	0.2–4.0 (1/64–3/16)	**** Yes (J)	No	Rfc. **	
Overcasting stitch		G	06	06	06	06	Overcasting on thin or medium weight fabrics	3.5 (1/8)	2.5–5.0 (3/32–3/16)	2.0 (1/16)	1.0–4.0 (1/16–3/16)	No	No	Rfc. **	
		G	07	07	07	07	Overcasting on thick fabrics	5.0 (3/16)	2.5–5.0 (3/32–3/16)	2.5 (3/32)	1.0–4.0 (1/16–3/16)	No	No	Rfc. **	
		J	08	08	08	08	Overcasting on stretch fabrics	5.0 (3/16)	0.0–7.0 (0–1/4)	2.5 (3/32)	0.5–4.0 (1/32–3/16)	**** Yes (J)	No	Rfc. **	

*Rev.: Reverse **Rfc.: Reinforcement ***Do not use reverse stitching.















****Select a stitch width of 5.0 mm (3/16 inch) or less.



















Stitch Name	Pattern	Presser Foot	Pattern No.				Application	Stitch Width [mm (inch.)]		Stitch Length [mm (inch.)]		Twin Needle	Walking Foot	Reverse/Reinforcement Stitching
			70 stitches model	60 stitches model	50 stitches model	40 stitches model		Auto	Manual	Auto	Manual			
Blind hem stitch		R	09	09	09	09	Blind hem stitching on medium weight fabrics	0 (0)	3 – 3	2.0 (1/16)	1.0–3.5 (1/16–1/8)	No	No	Rfc. *
		R	10	10	10	10	Blind hem stitching on stretch fabrics	0 (0)	3 – 3	2.0 (1/16)	1.0–3.5 (1/16–1/8)	No	No	Rfc. *
Appliqué stitch		J	11	11	11	11	Appliqué stitching	3.5 (1/8)	2.5–5.0 (3/32–3/16)	2.5 (3/32)	1.6–4.0 (1/16–3/16)	Yes** (J)	No	Rfc. *
Shell tuck stitch		J	12	12	12	12	Shell tuck stitching	4.0 (3/16)	0.0–7.0 (0–1/4)	2.5 (3/32)	0.2–4.0 (1/64–3/16)	Yes** (J)	No	Rfc. *
Satin scallop stitch		N	13	13	13	13	Scallop stitching	5.0 (3/16)	2.5–7.0 (3/32–1/4)	0.5 (1/32)	0.1–1.0 (1/64–1/16)	Yes** (J)	No	Rfc. *
Joining stitch		J	14	14	14	14	Patchwork stitching and decorative stitching	4.0 (3/16)	0.0–7.0 (0–1/4)	1.2 (1/16)	0.2–4.0 (1/64–3/16)	Yes** (J)	No	Rfc. *
		J	15	15	15	15	Patchwork stitching, decorative stitching and sewing overcasting on both pieces of fabrics, such as with tricot	5.0 (3/16)	2.5–7.0 (3/32–1/4)	2.5 (3/32)	1.0–4.0 (1/16–3/16)	Yes** (J)	No	Rfc. *
		J	16	16	16	16	Patchwork stitching and decorative stitching	5.0 (3/16)	0.0–7.0 (0–1/4)	1.2 (1/16)	0.2–4.0 (1/64–3/16)	Yes** (J)	No	Rfc. *
Fagoting stitch		J	17	17	17	17	Fagoting, smocking and decorative stitching	5.0 (3/16)	0.0–7.0 (0–1/4)	2.5 (3/32)	1.0–4.0 (1/16–3/16)	Yes** (J)	No	Rfc. *
		J	18	18	18	18	Fagoting, smocking and decorative stitching	5.0 (3/16)	2.5–7.0 (3/32–1/4)	2.5 (3/32)	1.0–4.0 (1/16–3/16)	Yes** (J)	No	Rfc. *
Decorative stitch		J	19	19	19	19	Decorative stitching	4.0 (3/16)	0.0–7.0 (0–1/4)	3.0 (1/8)	2.0–4.0 (1/16–3/16)	No	No	Rfc. *
		J	20	20	20	20	Decorative stitching	4.0 (3/16)	0.0–7.0 (0–1/4)	2.5 (3/32)	1.0–4.0 (1/16–3/16)	Yes** (J)	No	Rfc. *
		J	21	21	21	–	Decorative stitching	5.5 (7/32)	0.0–7.0 (0–1/4)	1.6 (1/16)	1.0–4.0 (1/16–3/16)	Yes** (J)	No	Rfc. *
		N	22	22	22	21	Decorative stitching and elastic-attaching	5.0 (3/16)	1.5–7.0 (1/64–1/4)	1.0 (1/16)	0.2–4.0 (1/64–3/16)	Yes** (J)	No	Rfc. *
		N	23	23	23	22	Lace sewing, decorative hemming, heirloom stitching, etc.	3.5 (1/8)	1.5–7.0 (1/16–1/4)	2.5 (3/32)	1.6–4.0 (1/16–3/16)	No	No	Rfc. *
		N	24	24	24	23	Decorative hemming, heirloom stitching, etc.	6.0 (15/64)	1.5–7.0 (1/16–1/4)	3.0 (1/8)	1.5–4.0 (1/16–3/16)	No	No	Rfc. *
		N	25	25	25	–	Decorative hemming on thin, medium weight and plain weave fabrics, heirloom stitching, etc.	5.0 (3/16)	1.5–7.0 (1/16–1/4)	3.5 (1/8)	1.5–4.0 (1/16–3/16)	No	No	Rfc. *

*Rfc.: Reinforcement

**Select a stitch width of 5.0 mm (3/16 inch) or less.

Stitch Name	Pattern	Presser Foot	Pattern No.				Application	Stitch Width [mm (inch.)]		Stitch Length [mm (inch.)]		Twin Needle	Walking Foot	Reverse/Reinforcement Stitching
			70 stitches model	60 stitches model	50 stitches model	40 stitches model		Auto	Manual	Auto	Manual			
Decorative stitch		N	26	26	26	24	Decorative hemming on thin, medium weight and plain weave fabrics, heirloom stitching, etc.	5.0 (3/16)	1.5-7.0 (1/16-1/4)	4.0 (3/16)	1.5-4.0 (1/16-3/16)	*** Yes (J)	No	Rfc.*
		N	27	27	27	-	Decorative hemming on thin, medium weight and plain weave fabrics, heirloom stitching, etc.	5.0 (3/16)	1.5-7.0 (1/16-1/4)	2.5 (3/32)	1.5-4.0 (1/16-3/16)	*** Yes (J)	No	Rfc.*
		N	28	28	28	-	Decorative hemming on thin, medium weight and plain weave fabrics, heirloom stitching, etc.	5.0 (3/16)	1.5-7.0 (1/16-1/4)	2.0 (1/16)	1.5-4.0 (1/16-3/16)	*** Yes (J)	No	Rfc.*
Buttonhole stitch		A	29	29	29	25	Horizontal buttonholes on thin and medium weight fabrics	5.0 (3/16)	3.0-5.0 (1/8-3/16)	0.4 (1/64)	0.2-1.0 (1/64-1/16)	No	No	Auto Rfc.**
		A	30	30	30	26	Secured buttonholes for fabrics that have backings	5.0 (3/16)	3.0-5.0 (1/8-3/16)	0.4 (1/64)	0.2-1.0 (1/64-1/16)	No	No	Auto Rfc.**
		A	31	31	31	27	Buttonholes for stretch or knit fabrics	6.0 (15/64)	3.0-6.0 (1/8-15/64)	1.0 (1/16)	0.5-2.0 (1/32-1/16)	No	No	Auto Rfc.**
		A	32	32	32	28	Buttonholes for stretch fabrics	6.0 (15/64)	3.0-6.0 (1/8-15/64)	1.5 (1/16)	1.0-3.0 (1/16-1/8)	No	No	Auto Rfc.**
		A	33	33	33	29	Keyhole buttonholes for thick or furry fabrics	7.0 (1/4)	3.0-7.0 (1/8-1/4)	0.5 (1/32)	0.3-1.0 (1/64-1/16)	No	No	Auto Rfc.**
		A	34	34	-	-	Keyhole buttonholes for medium weight and thick fabrics	7.0 (1/4)	3.0-7.0 (1/8-1/4)	0.5 (1/32)	0.3-1.0 (1/64-1/16)	No	No	Auto Rfc.**
		A	35	35	-	-	Keyhole buttonholes for thick or furry fabrics	7.0 (1/4)	3.0-7.0 (1/8-1/4)	0.5 (1/32)	0.3-1.0 (1/64-1/16)	No	No	Auto Rfc.**
Bar tack stitch		A	36	36	34	30	Reinforcing openings and areas where the seam easily comes loose	2.0 (1/16)	1.0-3.0 (1/16-1/8)	0.4 (1/64)	0.3-1.0 (1/64-1/16)	No	No	Auto Rfc.**
Piecing straight stitch		J	37	37	-	-	Piecing straight stitching (with a seam allowance of 6.5mm from the right edge of the presser foot)	5.5 (7/32)	0.0-7.0 (0-1/4)	1.6 (1/16)	0.2-5.0 (1/64-3/16)	No	Yes	Rfc.*
		J	38	38	-	-	Piecing straight stitching (with a seam allowance of 6.5mm from the right edge of the presser foot)	1.5 (1/16)	0.0-7.0 (0-1/4)	1.6 (1/16)	0.2-5.0 (1/64-3/16)	No	Yes	Rfc.*
Hand-look quilting		J	39	39	35	31	Straight stitch quilting that looks hand-sewn	0.0 (0)	0.0-7.0 (0-1/4)	2.5 (3/32)	1.0-4.0 (1/16-3/16)	No	No	Rfc.*
Zigzag stitch (for quilting)		J	40	40	-	-	Appliqué quilting, free-motion quilting, satin stitching, button sewing	3.5 (1/8)	0.0-7.0 (0-1/4)	1.4 (1/16)	0.0-4.0 (0-3/16)	No	Yes	Rfc.*

*Rfc.: Reinforcement **Auto Rfc.: Automatic Reinforcement
 ***Select a stitch width of 5.0 mm (3/16 inch) or less.

Stitch Name	Pattern	Presser Foot	Pattern No.				Application	Stitch Width [mm (inch.)]		Stitch Length [mm (inch.)]		Twin Needle	Walking Foot	Reverse/Reinforcement Stitching
			70 stitches model	60 stitches model	50 stitches model	40 stitches model		Auto	Manual	Auto	Manual			
Appliqué stitch (for quilting)		J	41	41	-	-	Attaching appliqués and binding	1.5 (1/16)	0.5–5.0 (1/32–3/16)	1.2 (1/16)	1.0–4.0 (1/16–3/16)	No	No	Rfc. *
		J	42	42	-	-	Attaching appliqués and binding	1.5 (1/16)	0.5–5.0 (1/32–3/16)	1.2 (1/16)	1.0–4.0 (1/16–3/16)	No	No	Rfc. *
Quilting stippling		J	43	43	-	-	Quilting background stitching (stippling)	7.0 (1/4)	1.0–7.0 (1/16–1/4)	1.6 (1/16)	1.0–4.0 (1/16–3/16)	No	No	Rfc. *
Decorative stitch		N	44	44	36	32	For decoration, etc.	7.0 (1/4)	0.0–7.0 (0–1/4)	2.5 (3/32)	0.2–4.0 (1/64–3/16)	No	No	Rfc. *
		N	45	45	37	33	For decoration, etc.	7.0 (1/4)	0.0–7.0 (0–1/4)	2.0 (1/16)	0.2–4.0 (1/64–3/16)	No	No	Rfc. *
		N	46	46	38	-	For decoration, etc.	7.0 (1/4)	0.0–7.0 (0–1/4)	2.5 (3/32)	0.2–4.0 (1/64–3/16)	No	No	Rfc. *
		N	47	-	-	-	For decoration, etc.	7.0 (1/4)	0.0–7.0 (0–1/4)	2.5 (3/32)	0.2–4.0 (1/64–3/16)	No	No	Rfc. *
		N	48	47	39	-	For decoration, etc.	7.0 (1/4)	0.0–7.0 (0–1/4)	2.0 (1/16)	0.2–4.0 (1/64–3/16)	No	No	Rfc. *
		N	49	48	40	-	For decoration, etc.	7.0 (1/4)	0.0–7.0 (0–1/4)	2.0 (1/16)	0.2–4.0 (1/64–3/16)	No	No	Rfc. *
		N	50	-	-	-	For decoration, etc.	7.0 (1/4)	0.0–7.0 (0–1/4)	1.6 (1/16)	0.2–4.0 (1/64–3/16)	No	No	Rfc. *
		N	51	49	41	34	For decoration, etc.	7.0 (1/4)	0.0–7.0 (0–1/4)	2.5 (3/32)	0.2–4.0 (1/64–3/16)	No	No	Rfc. *
		N	52	-	-	-	For decoration, etc.	7.0 (1/4)	0.0–7.0 (0–1/4)	2.0 (1/16)	0.2–4.0 (1/64–3/16)	No	No	Rfc. *
		N	53	-	-	-	For decoration, etc.	5.0 (3/16)	0.0–7.0 (0–1/4)	2.0 (1/16)	0.2–4.0 (1/64–3/16)	No	No	Rfc. *
		N	54	-	-	-	For decoration, etc.	7.0 (1/4)	0.0–7.0 (0–1/4)	2.5 (3/32)	0.2–4.0 (1/64–3/16)	No	No	Rfc. *
		N	55	50	-	-	For decoration, etc.	7.0 (1/4)	0.0–7.0 (0–1/4)	1.6 (1/16)	0.2–4.0 (1/64–3/16)	No	No	Rfc. *
	N	56	51	-	-	For decoration, etc.	7.0 (1/4)	0.0–7.0 (0–1/4)	1.4 (1/16)	0.2–4.0 (1/64–3/16)	No	No	Rfc. *	

*Rfc.: Reinforcement

Stitch Name	Pattern	Presser Foot	Pattern No.				Application	Stitch Width [mm (inch.)]		Stitch Length [mm (inch.)]		Twin Needle	Walking Foot	Reverse/Reinforcement Stitching
			70 stitches model	60 stitches model	50 stitches model	40 stitches model		Auto	Manual	Auto	Manual			
Satin stitches		N	57	52	42	-	For decoration, etc.	7.0 (1/4)	2.5-7.0 (3/32-1/4)	0.4 (1/64)	0.1-1.0 (1/64-1/16)	Yes** (J)	No	Rfc.*
		N	58	-	-	-	For decoration, etc.	7.0 (1/4)	2.5-7.0 (3/32-1/4)	0.4 (1/64)	0.1-1.0 (1/64-1/16)	Yes** (J)	No	Rfc.*
		N	59	53	43	35	For decoration, etc.	7.0 (1/4)	2.5-7.0 (3/32-1/4)	0.4 (1/64)	0.1-1.0 (1/64-1/16)	Yes** (J)	No	Rfc.*
		N	60	54	44	36	For decoration, etc.	7.0 (1/4)	2.5-7.0 (3/32-1/4)	0.4 (1/64)	0.1-1.0 (1/64-1/16)	Yes** (J)	No	Rfc.*
		N	61	55	45	-	For decoration, etc.	7.0 (1/4)	2.5-7.0 (3/32-1/4)	0.4 (1/64)	0.1-1.0 (1/64-1/16)	Yes** (J)	No	Rfc.*
		N	62	56	46	37	For decoration, etc.	7.0 (1/4)	2.5-7.0 (3/32-1/4)	0.4 (1/64)	0.1-1.0 (1/64-1/16)	Yes** (J)	No	Rfc.*
		N	63	-	-	-	For decoration, etc.	7.0 (1/4)	2.5-7.0 (3/32-1/4)	0.4 (1/64)	0.1-1.0 (1/64-1/16)	Yes** (J)	No	Rfc.*
		N	64	-	-	-	For decoration, etc.	7.0 (1/4)	2.5-7.0 (3/32-1/4)	0.4 (1/64)	0.1-1.0 (1/64-1/16)	Yes** (J)	No	Rfc.*
Cross-stitches		N	65	-	-	-	For decoration, etc.	7.0 (1/4)	0.0-7.0 (0-1/4)	1.6 (1/16)	0.2-4.0 (1/64-3/16)	No	No	Rfc.*
		N	66	-	-	-	For decoration, etc.	6.0 (15/64)	0.0-7.0 (0-1/4)	1.4 (1/16)	0.2-4.0 (1/64-3/16)	No	No	Rfc.*
		N	67	57	47	38	For decoration, etc.	6.0 (15/64)	0.0-7.0 (0-1/4)	2.5 (3/32)	0.2-4.0 (1/64-3/16)	No	No	Rfc.*
		N	68	58	48	-	For decoration, etc.	6.0 (15/64)	0.0-7.0 (0-1/4)	1.4 (1/16)	0.2-4.0 (1/64-3/16)	No	No	Rfc.*
		N	69	59	49	39	For decoration, etc.	6.0 (15/64)	0.0-7.0 (0-1/4)	1.4 (1/16)	0.2-4.0 (1/64-3/16)	No	No	Rfc.*

*Rfc.: Reinforcement

**Select a stitch width of 5.0 mm (3/16 inch) or less.

MAINTENANCE

Simple sewing machine maintenance operations are described below.

Restrictions on oiling

In order to prevent damaging this machine, it must not be oiled by the user.

This machine was manufactured with the necessary amount of oil applied to ensure correct operation, making periodic oiling unnecessary.

If problems occur, such as difficulty turning the handwheel or an unusual noise, immediately stop using the machine, and contact your authorized dealer or the nearest authorized service center.

Precautions on storing the machine

Do not store the machine in any of the locations described below, otherwise damage to the machine may result, for example, rust caused by condensation.

- Exposed to extremely high temperatures
- Exposed to extremely low temperatures
- Exposed to extreme temperature changes
- Exposed to high humidity or steam
- Near a flame, heater or air conditioner
- Outdoors or exposed to direct sunlight
- Exposed to extremely dusty or oily environments



Note

- In order to extend the life of this machine, periodically turn it on and use it. Storing this machine for an extended period of time without using it may reduce its efficiency.

Cleaning the machine surface

If the surface of the machine is dirty, lightly soak a cloth in neutral detergent, squeeze it out firmly, and then wipe the surface of the machine. After cleaning it once with a wet cloth, wipe it again with a dry cloth.

CAUTION

- **Unplug the power supply cord before cleaning the machine, otherwise injuries or an electric shock may occur.**

Cleaning the bobbin case

Sewing performance will suffer if dust collects in the bobbin case; therefore, it should be cleaned periodically.

CAUTION

- **Make sure you unplug the machine before you clean it. Otherwise, you may get an electric shock or be injured.**

- 1 Switch the machine off and unplug it.
- 2 Raise the needle and the presser foot.
- 3 Loosen the presser-foot screw and the needle clamp screw to remove the presser-foot holder and the needle.

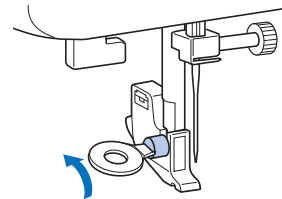

- 4 Grasp both sides of the needle plate cover, and then slide it toward you to remove the needle plate cover.

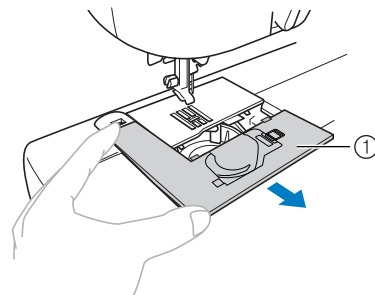

① Needle plate cover

- 5** Remove the bobbin case.
Grasp the bobbin case, and then pull it out.

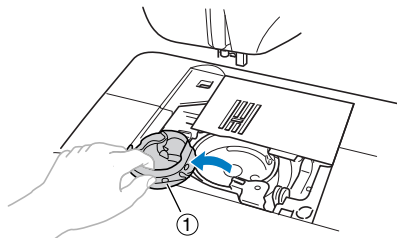

① Bobbin case

- 6** Use the cleaning brush or a vacuum cleaner to remove any dust from the race and its surrounding area.

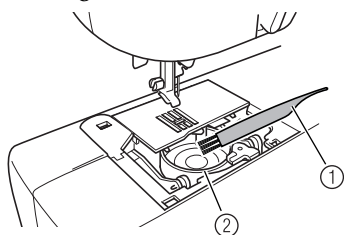

① Cleaning brush
② Race

- Do not put oil on the bobbin case.

- 7** Insert the bobbin case so that the ▲ mark on the bobbin case aligns with the ⚙ mark on machine as shown below.

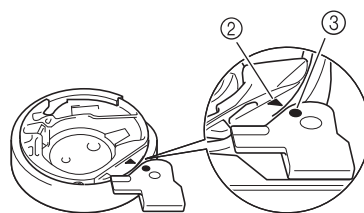
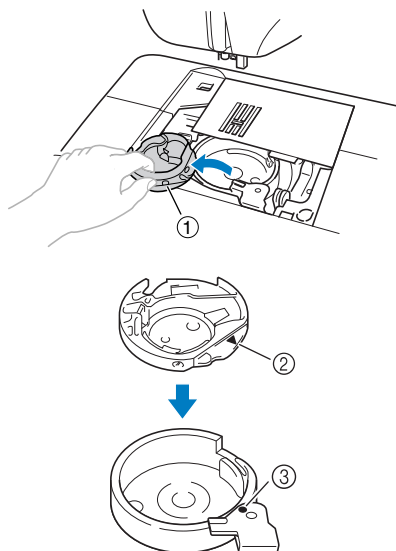

- Align the ▲ and ● marks.

① Bobbin case
② ▲ mark
③ ● mark

- Make sure that the indicated points are aligned before installing the bobbin case.

⚠ CAUTION

- Never use a bobbin case that is scratched, otherwise the upper thread may become tangled, the needle may break or sewing performance may suffer. For a new bobbin case (part code: XE7560-001), contact your nearest authorized service center.
- Make sure that you fit the bobbin case properly, otherwise the needle may break.

- 8** Put the tabs on the needle plate cover into the needle plate, and then slide the cover back on.

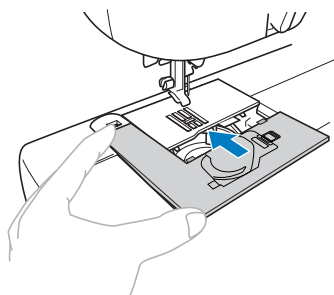



TROUBLESHOOTING

If the machine stops working properly, check the following possible problems.

If the problem is still there, contact your retailer or the nearest authorized service center.

Symptom	Possible cause	How to put it right	Reference
The sewing machine does not work.	The machine is not plugged in.	Plug the machine in.	page 7
	The main power switch is turned off.	Turn on the main power switch.	page 7
	The bobbin winder shaft is pushed to the right.	Move the bobbin winder shaft to the left.	page 10, 11
	You have not used the foot controller properly.	Use the foot controller properly.	page 7
The needle breaks.	The needle is not fitted properly.	Fit the needle properly.	page 17
	The needle clamp screw is loose.	Use the disc-shaped screwdriver to firmly tighten the screw.	page 18
	The needle is bent or blunt.	Replace the needle.	page 17
	You have not used the right combination of fabric, thread and needle.	Choose a thread and needle that are appropriate for the type of fabric.	page 16
	The presser foot you are using is not appropriate for the type of stitch that you want to sew.	Attach the presser foot that is correct for the type of stitch that you want to sew.	page 45
	The upper thread tension is too tight.	Loosen the upper thread tension.	page 25
	You are pulling the fabric too much.	Lightly guide the fabric.	–
	The area around the hole in the needle plate is scratched.	Replace the needle plate. Contact your retailer or the nearest authorized service center.	–
	The area around the hole in the presser foot is scratched.	Replace the presser foot. Contact your retailer or the nearest authorized service center.	–
	The bobbin case is scratched.	Replace the bobbin case. Contact your retailer or the nearest authorized service center.	–
The upper thread breaks.	You have not threaded the upper thread properly. (for example, you have not fitted the spool properly, or the thread has come out of the guide above the needle.)	Correct the upper threading.	page 13
	There are knots or tangles in the thread.	Remove any knots or tangles.	–
	The needle is not appropriate for the thread you are using.	Choose a needle that is appropriate for the type of stitch.	page 16
	The upper thread tension is too tight.	Loosen the upper thread tension.	page 25
	The thread is tangled, for example, in the bobbin case.	Remove the tangle thread. If the thread is tangled in the bobbin case, clean the bobbin case.	page 50
	The needle is bent or blunt.	Replace the needle.	page 17

Symptom	Possible cause	How to put it right	Reference
The upper thread breaks.	You have not inserted the needle properly.	Insert the needle properly.	page 17
	The area around the hole in the needle plate is scratched.	Replace the needle plate. Contact your retailer or the nearest authorised service center.	–
	The area around the hole in the presser foot is scratched.	Replace the presser foot. Contact your retailer or the nearest authorised service center.	–
	The bobbin case is scratched, or has a burr on it.	Replace the bobbin case. Contact your retailer or the nearest authorised service center.	–
	You have not used a bobbin that has been designed for this machine.	Incorrect bobbins will not work properly. Only use a bobbin that has been designed for this machine.	page 9
The lower thread is tangled or breaks.	You have not wound the bobbin thread properly.	Wind the bobbin thread properly.	page 9
	The bobbin is scratched or does not turn smoothly.	Replace the bobbin.	–
	The thread is tangled.	Remove the tangled thread and clean the bobbin case.	page 50
	You have not used a bobbin that has been designed for this machine.	Incorrect bobbins will not work properly. Only use a bobbin that has been designed for this machine.	page 9
	Bobbin is set incorrectly.	Reset the bobbin thread correctly.	page 11, 12
The thread tension is incorrect.	You have not threaded the upper thread properly.	Correct the upper threading.	page 13
	You have not wound the bobbin thread properly.	Wind the bobbin thread properly.	page 9
	You have not threaded the right combination of thread and needle for the fabric you are using.	Choose a thread and needle that are appropriate for the type of fabric.	page 16
	You have not attached the presser-foot holder properly.	Attach the presser-foot holder properly.	page 21
	The thread tension is incorrect.	Adjust the tension of the upper thread.	page 25
	You have not used a bobbin that has been designed for this machine.	Incorrect bobbins will not work properly. Only use a bobbin that has been designed for this machine.	page 9
	Bobbin is set incorrectly.	Reset the bobbin thread correctly.	page 11, 12
The fabric is wrinkled.	You have not threaded the upper thread properly or fitted the bobbin properly.	Thread the upper thread and wind the bobbin thread properly.	page 11, 12, 13
	You have not fitted the spool properly.	Fit the spool properly.	–
	You have not used the right combination of fabric, thread and needle.	Choose a thread and needle that are appropriate for the type of fabric.	page 16
	The needle is bent or blunt.	Replace the needle.	page 17
	If you are sewing thin fabric, the stitch is too thick.	Sew with stabiliser material under the fabric.	page 26
	The thread tension is incorrect.	Adjust the tension of the upper thread.	page 25

Symptom	Possible cause	How to put it right	Reference
Stitches are skipped.	You have not threaded the upper thread properly.	Correct the upper threading.	page 13
	You have not used the right combination of fabric, thread and needle.	Choose a thread and needle that are appropriate for the type of fabric.	page 16
	The needle is bent or blunt.	Replace the needle.	page 17
	You have not inserted the needle properly.	Insert the needle properly.	
	Dust has accumulated under the needle plate or in the bobbin case.	Remove the needle plate cover and clean the plate and the bobbin case.	page 50
There is a high-pitched noise while sewing.	Dust has built up in the feed dogs or in the bobbin case.	Clean the bobbin case.	page 50
	You have not threaded the upper thread properly.	Correct the upper threading.	page 13
	The bobbin case is scratched.	Replace the bobbin case. Contact your retailer or the nearest authorized service center.	–
	You have not used bobbin that has been designed for this machine.	Incorrect bobbins will not work properly. Only use a bobbin that has been designed for this machine.	page 9
The needle threader can not be used.	You have not moved the needle holder to its highest position.	Raise the needle either by turning the handwheel toward you (counterclockwise) so that the mark on the wheel points up or by pressing  (needle position button) once or twice.	page 13
	You have not inserted the needle properly.	Insert the needle properly.	page 17
The stitch is not sewn correctly.	The presser foot that you are using is not correct for the type of stitch.	Attach the presser foot that is correct for the type of stitch that you want to sew.	page 45
	The thread tension is incorrect.	Adjust the tension of the upper thread.	page 25
	The thread is tangled, for example, in the bobbin case.	Remove the tangle thread. If the thread is tangled in the bobbin case, clean the bobbin case.	page 50
The fabric does not feed.	The feed dogs are lowered.	Slide the feed dog position lever to  .	page 33, 39
	The stitch is too fine.	Lengthen the stitch length.	page 23
	You have not used the right combination of fabric, thread and needle.	Choose a thread and needle that are appropriate for the type of fabric.	page 16
	The thread is tangled, for example, in the bobbin case.	Remove the tangle thread. If the thread is tangled in the bobbin case, clean the bobbin case.	page 50
The sewing light bulb does not come on.	The sewing lamp is damaged.	Contact your retailer or the nearest authorized service center.	–

ERROR MESSAGES

If an operation is performed incorrectly before the sewing machine is set up, an error message appears on the operation panel. Follow the instructions indicated in the table.

If you press the stitch selection key or do the operation correctly while the error message is displayed, the message disappears.

Error Message	Probable Cause	Solution
E1	The foot controller was pressed (or the start/stop button was pressed if the foot controller is not connected) and the reverse/reinforcement stitch button was pressed while the presser foot is raised.	Lower the presser foot lever before continuing the operation.
E2	A stitch other than the buttonhole or bar tack stitch was selected and the foot controller was pressed (or the start/stop button was pressed if the foot controller is not connected) while the buttonhole lever is lowered.	Raise the buttonhole lever before continuing the operation.
E3	The buttonhole or bar tack stitch was selected and the foot controller was pressed (or the start/stop button was pressed if the foot controller is not connected) while the buttonhole lever is raised.	Lower the buttonhole lever before continuing the operation.
E4	The reverse/reinforcement stitch button or needle position button was pressed while the bobbin winder shaft is moved to the right.	Move the bobbin winder shaft to the left before continuing the operation.
E5	The start/stop button was pressed while the foot controller was connected.	Disconnect the foot controller, and then press the start/stop button. Otherwise, operate the machine by using the foot controller.
E6	The motor locked up because the thread is tangled.	Remove the tangled thread before continuing the operation.



Note

- If error message "F1" through "F8" appears in the LCD while the sewing machine is being used, the machine may be malfunctioning. Contact your nearest authorized service center.

Operation beep (for models equipped with the operation beep)

Each time a key is pressed you will hear one beep. If a non-functioning key is pressed or an incorrect operation is performed you will hear two or four beeps (only for models equipped with the operation beep).

- **If a key is pressed (correct operation)**
One beep sounds.
- **If an incorrect operation is performed or a non-functioning key is pressed**
Two or four beeps sound.
- **If the machine locks up, for example, because the thread is tangled**
The sewing machine beeps for four seconds and the machine automatically stops. Be sure to check for the cause of the error, and correct it before continuing to sew.

INDEX

Numerics

3-point zigzag stitch 28

A

accessories 6

appliqués 36

B

bar tack 40

basic stitching 28

blind hem stitching 29

bobbin case 50

bobbin cover 4, 11

bobbin winder 9, 52, 55

button sewing 33

buttonhole lever 4, 31, 40

buttonhole sewing 30

C

crazy quilt stitching 36

E

elastic tape 35

error messages 55

extra spool pin 19

eyelet punch 32

F

fagoting 41

fast bobbin winding 10

feed dog position lever 39

feed dogs 4, 39

flat bed attachment 5, 27

foot controller 6, 24

free-arm style 27

free-motion quilting 38

H

handwheel 4

heirloom stitching 44

J

joining 43

joining stitch 36, 41

L

LCD 5

M

main parts 4

main power switch 7

monogramming 42, 44

N

needle 16

needle bar thread guide 5

needle clamp screw 5

needle plate 5

needle plate cover 50

needle position 29

needle position button 5

needle threader 14

O

openings 40

operation beep 55

operation buttons 5

operation panel 5

optional accessories 6

overcasting stitches 28

P

patchwork stitching 36

piecing 37

pocket corners 40

presser foot 4, 20

presser foot holder 4, 21

presser foot lever 5, 13

pre-tension disk 9

Q

quick-set bobbin 4, 12

quilting 37

quilting foot 38

quilting guide 37, 38

R

reinforcement stitching 39

reverse/reinforcement stitch button 5

S

scallop stitching 42

seam ripper 32

sewing machine needles 16

sewing speed controller 5

sleeve holes 39

smocking 42

spool pin 9, 13

start/stop button 5, 24

stitch length 23

stitch selection key 5

stitch settings 45

stitch width 23

straight stitch 28

stretch fabrics 26

T

thick fabrics 26

thin fabrics 26

thread guide 13

thread tension 25

trial sewing 25

triple stretch stitch 29, 39

troubleshooting 52

twin needle 19

U

upper tension-control dial 25

upper threading 13

W

walking foot 37

wing needle 44

Z

zigzag stitch 26, 28, 36

zipper foot 34

zipper Insertion 34

Please visit us at <http://support.brother.com/> where you can get product support and answers to frequently asked questions (FAQs).

English
888-S33/S36
Printed in Vietnam



XG8483-001